

**Layer 3 32-Port 100G/40G QSFP28 + 2-Port 10G SFP+ Managed
Data Center Switch**

**Layer 3 48-Port 25G SFP28 + 8-Port 100G/40G QSFP28 Managed
Data Center Switch**

DCS-7342-32C2X/DCS-7342-48Y8C

Quick Installation Guide

Table of Contents

1. Package Contents	3
2. Switch Management.....	4
3. Requirements	5
4. Terminal Setup	6
4.1 Logging on to the Console	7
4.2 Configuring IP Address	8
4.3 Setting 25G for 10G SFP+ Port.....	10
4.4 Setting 40GBASE-X for 100G SFP+ Port.....	10
4.5 Saving the Configuration	11
5. SSH Login.....	12
6. LED Indicators.....	14
6.1 DCS-7342-32C2X.....	14
6.2 DCS-7342-48Y8C.....	15
7. Customer Support	17

1. Package Contents

Thank you for purchasing PLANET Layer 3 Managed **Data Center Switches, DCS-7342-Series** (DCS-7342-32C2X and DCS-7342-48Y8C). Unless specified, **“Managed Switch”** mentioned in this Quick Installation Guide refers to the DCS-7342-32C2X and DCS-7342-48Y8C.

Model	Description
DCS-7342-32C2X	Layer 3 32-Port 100G/40G QSFP28 + 2-Port 10G SFP+ Managed Data Center Switch
DCS-7342-48Y8C	Layer 3 48-Port 25G SFP28 + 8-Port 100G/40G QSFP28 Managed Data Center Switch

Open the box of the **Managed Switch** and carefully unpack it. The box should contain the following items:

	DCS-7342-32C2X	DCS-7342-48Y8C
QR Code Sheet	■	■
RS232 to RJ45 Console Cable	■	■
Rack Mount Accessory Kit	■	■
AC Power Cord	2	2
Rubber Feet	4	4
SFP Dust Cap	34	56

If any item is found missing or damaged, please contact your local reseller for replacement.

2. Switch Management

To set up the Managed Switch, the user needs to configure the Managed Switch for network management. The Managed Switch provides two management options: **Out-of-Band Management** and **In-Band Management**.

■ Out-of-Band Management

Out-of-band management is the management through console interface. **Generally, the user will use out-of-band management for the initial switch configuration**, or when in-band management is not available.

■ In-Band Management

In-band management refers to the management by logging in to the Managed Switch using Telnet or HTTPs, or using SNMP management software to configure the Managed Switch. In-band management enables the management of the Managed Switch to attach some devices to the Switch. The following procedures are required to enable in-band management:

1. Log on to console
2. Assign/Configure IP address
3. Create a remote login account
4. Enable HTTPs or Telnet server on the Managed Switch

In case in-band management fails due to Managed Switch configuration changes, out-of-band management can be used for configuring and managing the Managed Switch.

3. Requirements

- **Workstations** running Windows 10/11, macOS 10.16 or later, Linux, UNIX, or other platforms that are compatible with TCP/IP Protocols.
- Workstations are installed with Ethernet NIC (Network Interface Card)
- **Serial Port Connection** (Terminal)
 - The above Workstations come with COM Port (DB9) or USB-to-RS232 converter.
 - The above Workstations have been installed with terminal emulator, such as Tera Term or PuTTY.
 - Serial cable -- One end is attached to the RS232 serial port, while the other end to the console port of the Managed Switch.
- Management Port Connection
 - Network cables -- Use standard network (UTP) cables with RJ45 connectors.
 - The above PC is installed with Tera Term or PuTTY

4. Terminal Setup

To configure the system, connect a serial cable to a **COM port** on a PC or notebook computer and to serial (console) port of the Managed Switch. The console port of the Managed Switch is DCE already, so that you can connect the console port directly through PC without the need of Null Modem.

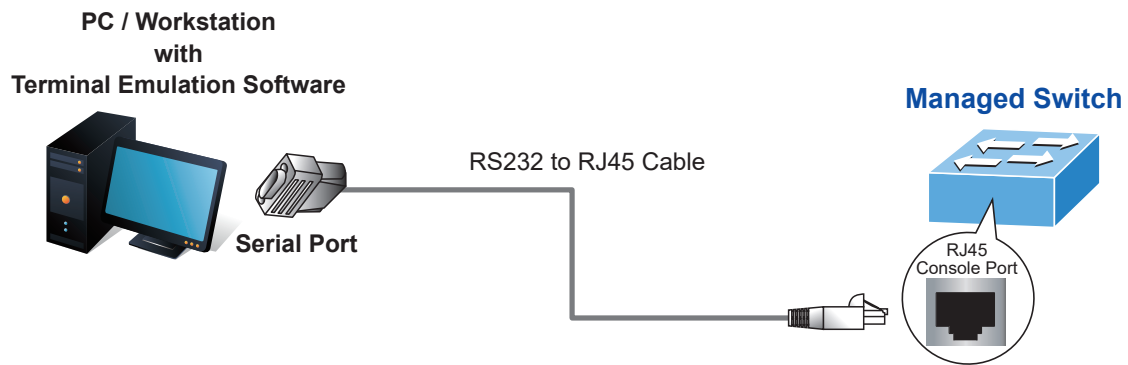

Figure 4-1: Managed Switch Console Connectivity

A terminal program is required to make the software connection to the Managed Switch. Tera Term program may be a good choice. The Tera Term can be accessed from the Start menu.

1. Click **START** menu, then **Programs**, and then **Tera Term**.
2. When the following screen appears, make sure that the COM port should be configured as:

- ◆ Baud: 115200
- ◆ Parity: None
- ◆ Data bits: 8
- ◆ Stop bits: 1
- ◆ Flow control: None

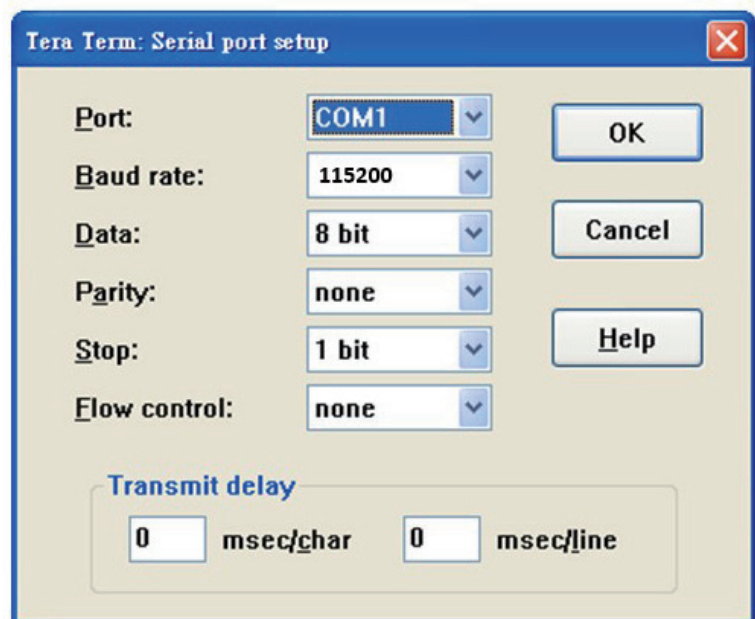

Figure 4-2: Tera Term COM Port Configuration

4.1 Logging on to the Console

Once the terminal is connected to the device, power on the Managed Switch, and the terminal will display **“running testing procedures”**.

Then, the following message asks for the login user name and password. The factory default user name and password are as follows as the login screen in Figure 4-4 appears.

Username: **admin**
Password: **sw + the last 6 characters of the MAC ID in lowercase**

Find the MAC ID on your device label. The default password is “sw” followed by the last six lowercase characters of the MAC ID.

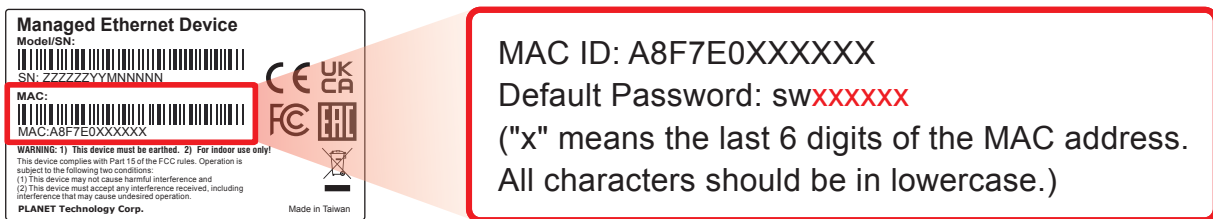

Figure 4-3: MAC ID Label

Enter the default username and password, then set a new password according to the rule-based prompt and confirm it.

```
Username: admin
Password: *****

Please input a new password:*****
Please input the new password AGAIN:*****

Switch>Jan 1 00:10:28 User admin logged in from on console 0
Switch>enable
Switch#Jan 1 00:10:34 User admin enter privilege mode from console 0, level = 15
Switch#
```

Figure 4-4: Managed Switch Console Login Screen

The user can now enter commands to manage the Switch. For a detailed description of the commands, please refer to the following sections.



Note

1. For security reason, **please change and memorize the new password after this first setup.**
2. Accept command in lowercase or uppercase letter under console interface.

4.2 Configuring IP Address

The IP address configuration commands for **VLAN1 interface** are listed below. Before using in-band management, the Managed Switch must be configured with an IP address by out-of-band management (i.e. console mode). The configuration commands are as follows:

```
Switch# config
Switch(config)# interface vlan 1
Switch(config-vlanif-1)# ip address 192.168.0.100 255.255.255.0
```

The previous command would apply the following settings for the Managed Switch.

IPv4 Address: 192.168.0.100
Subnet Mask: 255.255.255.0

```
DCS-7342-48Y8C#con
DCS-7342-48Y8C#configure
  %Enter configuration commands.End with Ctrl+Z or command "quit" & "end"
DCS-7342-48Y8C(config)#inter
DCS-7342-48Y8C(config)#interface vlan 1
DCS-7342-48Y8C(config-vlanif-1)#ip
address                binding                dhcp
direct-route          ospf                   pim
pim-sm                policy-based-route    rip
router                vrrp                  vrrpv3
DCS-7342-48Y8C(config-vlanif-1)#ip add
DCS-7342-48Y8C(config-vlanif-1)#ip address 192.168.0.100 255.255.255.0
DCS-7342-48Y8C(config-vlanif-1)#
```

Figure 4-5: Configuring IPv4 Address Screen

To check the current IP address or modify a new IP address for the Managed Switch, please use the procedures as follows:

■ Show the current IP address

1. On **"Switch#" prompt**, enter **"show ip interface"**.
2. The screen displays the current IP address, subnet mask and gateway as shown in Figure 4-6.

```
DCS-7342-32C2X#config
%Enter configuration commands.End with Ctrl+Z or command "quit" & "end"
DCS-7342-32C2X(config)#interface vlan 1
DCS-7342-32C2X(config-vlanif-1)#ip address 192.168.0.100 255.255.255.0
DCS-7342-32C2X(config-vlanif-1)#
DCS-7342-32C2X(config)#show ip inter
DCS-7342-32C2X(config)#show ip interface
The total number of Ip address: 2
Ip-Address      Interface      IPIndex  State(a/o)   Role      Type      Vpn-instance
127.0.0.1/8     loopback0     1        up/up        primary   auto      N/A
192.168.0.100/24  vlan1         2        up/down     primary   static    N/A
DCS-7342-32C2X(config)#
```

Figure 4-6: Showing IP Information Screen

If the IP is successfully configured, the Managed Switch will apply the new IP address setting immediately. You can access the Web interface of Managed Switch through the new IP address.



Note If you are not familiar with console command or the related parameter, enter **"help"** anytime in console to get the help description.

4.3 Setting 25G for 10G SFP+ Port

For DCS-7342-48Y8C only.

The Managed Switch supports both **25G** SFP28 and **10G** SFP+ transceivers by manual setting and the default SFP28 port speed is set to 25Gbps. For example, to establish the fiber connection with 10G SFP+ transceiver in the **10gigaethernet 1/0/1**, the following command configuration is required:

```
DCS-7342-48Y8C#con
DCS-7342-48Y8C#configure
  %Enter configuration commands.End with Ctrl+Z or command "quit" & "end"
DCS-7342-48Y8C(config)#port mode 10g
DCS-7342-48Y8C(config)#port mode 10gi inter
DCS-7342-48Y8C(config)#port mode 10gi interface 25g
DCS-7342-48Y8C(config)#port mode 10gi interface 25gigaethernet 1/0/1
Warning: This operation will delete current port(s) and create new port(s),
and all configurations of the current port(s) will be cleared.
Continue? (y/n) [n]y
DCS-7342-48Y8C(config)#
DCS-7342-48Y8C(config)#
```

Figure 4-7: Setting 10GBASE-X Screen

4.4 Setting 40GBASE-X for 100G SFP+ Port

The Managed Switch supports both **40GBASE-X** and **100GBASE-X** SFP transceivers by manual setting and the default SFP+ port speed is set to 100Gbps. Before Configuring the port, ensure that the 40G QSFP fiber is connected. For example, to establish the fiber connection with 40GBASE-X SFP transceiver in the **100gigaethernet 1/0/1**, the following command configuration is required:

```
DCS-7342-48Y8C#con
DCS-7342-48Y8C#configure
  %Enter configuration commands.End with Ctrl+Z or command "quit" & "end"
DCS-7342-48Y8C(config)#inter
DCS-7342-48Y8C(config)#interface 100
DCS-7342-48Y8C(config)#interface 100gigaethernet 1/1/1
DCS-7342-48Y8C(config-100ge1/1/1)#spe
DCS-7342-48Y8C(config-100ge1/1/1)#speed 40000
DCS-7342-48Y8C(config-100ge1/1/1)#
```

Figure 4-8: Setting 40GBASE-X Screen

4.5 Saving the Configuration

In Managed Switch, the running configuration file stores in the RAM. In the current version, the running configuration sequence running-config can be saved from the RAM to FLASH by "**write file**" command, so that the running configuration sequence becomes the start-up configuration file, which is called configuration save.

```
Switch# write file
```

```
DCS-7342-48Y8C#write file
This will save the configuration in the flash memory.
Are you sure?(y/n) [y]y

Building configuration,please wait for a moment.....
[OK]
DCS-7342-48Y8C#
```

Figure 4-9: Write Screen

5. SSH Login

The Managed Switch also supports SSHv2 for remote management. The switch asks for user name and password for remote login when using SSHv2 client software; please use the default username and password. Refer to Figure 4-3 to determine your initial login password.

Default IP address: **192.168.0.100**

Username: **admin**

Password: **sw + the last 6 characters of the MAC ID in lowercase**

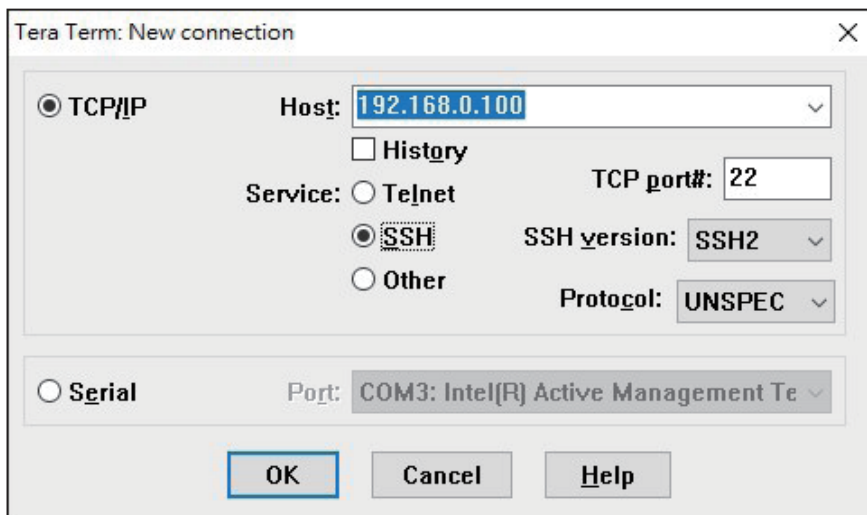

Tera Term: New connection

TCP/IP Host: 192.168.0.100

History

Service: Telnet TCP port#: 22

SSH SSH version: SSH2

Other Protocol: UNSPEC

Serial Port: COM3: Intel(R) Active Management Te

OK Cancel Help

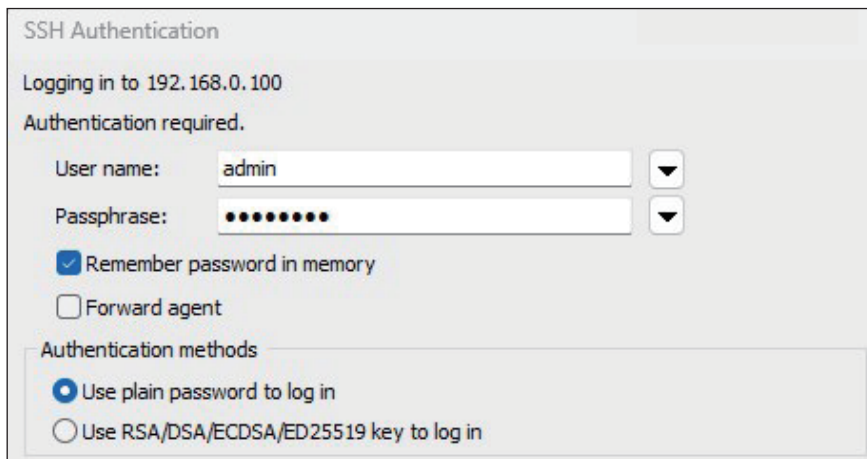

SSH Authentication

Logging in to 192.168.0.100

Authentication required.

User name: admin

Passphrase: ●●●●●●

Remember password in memory

Forward agent

Authentication methods

Use plain password to log in

Use RSA/DSA/ECDSA/ED25519 key to log in

```
You are required to change and store a new password to be able to get into the switch.
Please store your new password in a safe, retrievable place for safe keeping.
Once configured, also store a copy of your Config File in a safe, retrievable place for safe keepin
g.
Password: The password must contain 8-31 characters, including upper case, lower case, numerals, an
d other symbols. Please note, spaces (blanks) are not accepted.

(New)Password: █
```

Figure 5-1: Managed Switch SSHv2 Login Screen

The user can now enter commands to manage the Managed Switch. For a detailed description of the commands, please refer to the following chapters.



Note

For security reason, please change and memorize the new password after this first setup.

6. LED Indicators

6.1 DCS-7342-32C2X

■ Front Panel:

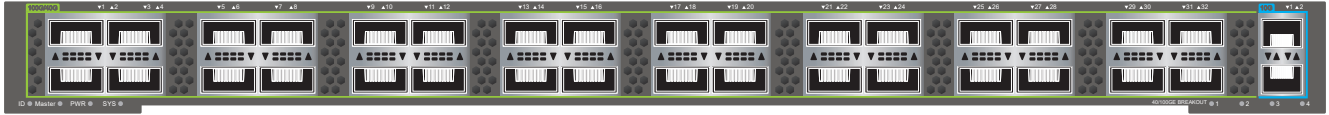

■ LED Definition

LED	Color	Function
ID	Green	Off: ID light is not activated by default.
		On: Used for on-site identification, controlled by maintenance personnel to turn the ID light on and off.
Master	Green	Off: Device is not the stack master.
		On: Device is the stack master or not stacked.
PWR	Green	Off: Device is not powered on.
		On: Device power is working normally.
SYS	Green	Off: Device is not running.
		Fast Blinking: Device initialization is in progress.
		Slow Blinking: Device is running normally.
100/40GE BREAKOUT	Green	<div style="border: 1px solid #add8e6; padding: 5px; display: flex; align-items: center;">  <p>For 100GE interface, it supports non-rate-splitting and rate-splitting.</p> </div>
		<p>Non-rate-splitting mode:</p> <p>Off: 100GE interface operates in 100GE mode, not split into four 25GE interfaces.</p> <p>On: One of the 100GE interfaces operates in 25GE mode, split into four 25GE interfaces. Sequence lights 1/2/3/4 are on with each indicating the status of the corresponding 25GE interface.</p> <p>Rate-splitting mode to 40GE:</p> <p>Off: 40GE interface operates in 40GE mode, not split into four 10GE interfaces.</p> <p>On: One of the 40GE interfaces operates in 10GE mode, split into four 10GE interfaces. Sequence lights 1/2/3/4 are on with each indicating the status of the corresponding 10GE interface.</p>

ACT	Green	Off: Fan is not running. On: Fan is running normally.
ALM	Red	On: Fan alarm. Blinking: Main control is unable to control fan. Fan adjusts speed according to environmental temperature.
ACT	Green	Off: USB boot is not enabled by default. On: USB boot is completed. Blinking: Reading USB data.
L/A	Green	Off: Link is not connected. On: Link is connected. Blinking: Interface is transmitting and receiving data.

6.2 DCS-7342-48Y8C

■ Front Panel:



■ LED Definition

LED	Color	Function
ID	Green	Off: ID light is not activated by default.
		On: Used for on-site identification, controlled by maintenance personnel to turn the ID light on and off.
Master	Green	Off: Device is not the stack master.
		On: Device is the stack master or not stacked.
PWR	Green	Off: Device is not powered on.
		On: Device power is working normally.
SYS	Green	Off: Device is not running.
		Fast Blinking: Device initialization is in progress. Slow Blinking: Device is running normally.

100/40GE BREAKOUT	Green	<div data-bbox="464 219 619 398" style="border: 1px solid black; padding: 5px; margin-bottom: 10px;">  Note </div> <p>For 100GE interface, it supports non-rate-splitting and rate-splitting.</p> <p>Non-rate-splitting mode: Off: 100GE interface operates in 100GE mode, not split into four 25GE interfaces. On: One of the 100GE interfaces operates in 25GE mode, split into four 25GE interfaces. Sequence lights 1/2/3/4 are on with each indicating the status of the corresponding 25GE interface.</p> <p>Rate-splitting mode to 40GE: Off: 40GE interface operates in 40GE mode, not split into four 10GE interfaces. On: One of the 40GE interfaces operates in 10GE mode, split into four 10GE interfaces. Sequence lights 1/2/3/4 are on with each indicating the status of the corresponding 10GE interface.</p>
ACT	Green	Off: Fan is not running. On: Fan is running normally.
ALM	Red	On: Fan alarm. Blinking: Main control unable to control fan. Fan adjusts speed according to environmental temperature.
ACT	Green	Off: USB boot is not enabled by default. On: USB boot os completed. Blinking: Reading USB data.
L/A	Green	Off: Link is not connected. On: Link is connected. Blinking: Interface is transmitting and receiving data.
25GE Left light(Link)	Green	Off: Port is not connected or disabled. On: Port is connected.
25GE Right light(ACT)	Orange	Off: No data transmission on the port. On: Blinking Port is transmitting data.

7. Customer Support

Thank you for purchasing PLANET products. You can browse our online FAQ resource at the PLANET Web site first to check if it could solve your issue. If you need more support information, please contact PLANET support team.

PLANET online FAQs:

<https://www.planet.com.tw/en/support/faq>

Support team mail address:

support@planet.com.tw

DCS-7342-32C2X/DCS-7342-48Y8C User's Manual

<https://www.planet.com.tw/en/support/download.php?view=3&key=DCS-7342#list>



Copyright © PLANET Technology Corp. 2024.

Contents are subject to revision without prior notice.

PLANET is a registered trademark of PLANET Technology Corp.

All other trademarks belong to their respective owners.