

**Industrial IP67 1-Port 60W 802.3bt**

**PoE++ Injector**

**IPOE-175**

User's Manual

# Table of Contents

1. Package Contents.....	3
2. Hardware Introduction .....	4
2.1 Product Outlook.....	4
2.2 Power Input Port .....	4
2.3 Data Input Port and 802.3bt PoE++ Output Port .....	5
2.4 LED Indicators.....	5
3. Installation .....	6
3.1 Installing Cable Gland with Power Cable and RJ45 UTP Cable .....	6
3.2 Connecting Waterproof Cable Kit to the Outdoor PoE Injector .....	6
3.3 Wall-mount Installation .....	9
3.4 Connecting IPOE-175 to PD .....	10
3.5 Connecting IPOE-175 to PD .....	10
4. Product Specifications .....	12
Customer Support.....	14

# 1. Package Contents

Thank you for purchasing PLANET Industrial IP67 1-port 10/100/1000/2500T 802.3bt PoE++ Injector, IPOE-175. In the following sections, the term **"Outdoor PoE Injector"** means the IPOE-175.

Open the box of the Industrial Ethernet Switch and carefully unpack it. The box should contain the following items:

IPOE-175 x 1	QR code sheet x 1	Wall-mounted Kit x 1
		 Spanner x 1
Power Cable with 2-pin Terminal Block x 1	M22 Waterproof Cable Gland x 3	
		Ground Wire x 1 

If any of these are missing or damaged, please contact your dealer immediately; if possible, retain the carton including the original packing material, and use them again to repack the product in case there is a need to return it to us for repair.

Remarks: The color of the ground wire is different according to the batch, but its wire specifications meet the standard.

## 2. Hardware Introduction

This section describes the functionalities of the outdoor PoE Injector's components.

### 2.1 Product Outlook

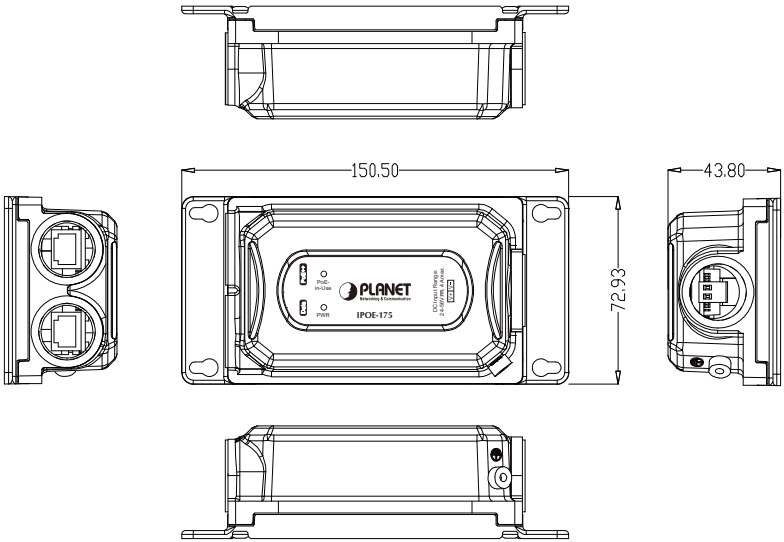

Unit: mm

Figure 2-1: IPOE-175 product outlook

### 2.2 Power Input Port

Figure 2-2 shows the power input port side of the IPOE-175

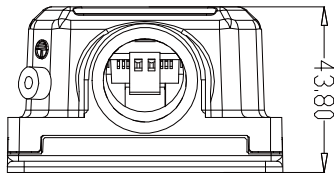

Figure 2-2: Power Input Port

## 2.3 Data Input Port and 802.3bt PoE++ Output Port

Figure 2-3 shows the data input port and PoE++ output port side of the IPOE-175.

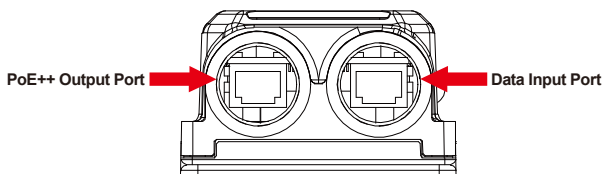

Figure 2-3: Two RJ45 Ports

## 2.4 LED Indicators

LED	Color	Function
PWR	Green	Indicates it has power.
PoE-in-Use	Amber	Indicates the port is providing power.

To install the 2-pin Terminal Block Connector on the **Outdoor PoE Injector**, simply follow the following steps:

**Step 1:** Insert positive DC power wire into **V+**, negative DC power wire into **V-**, and grounding wire into **Ground**.

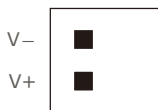

2-pin

**Step 2:** Tighten the wire-clamp screws for preventing the wires from loosening and plug them into the Wall-mount Gigabit Ethernet Router



### Note

1. The wire gauge should be in the range from 20 to 22 AWG.
2. The device must be grounded.

### 3. Installation

This section describes how to install the Outdoor PoE Injector and make connections to it. Please read the following topics and perform the procedure in the order being presented.

#### 3.1 Installing Cable Gland with Power Cable and RJ45 UTP Cable

The cable gland consists of the following:

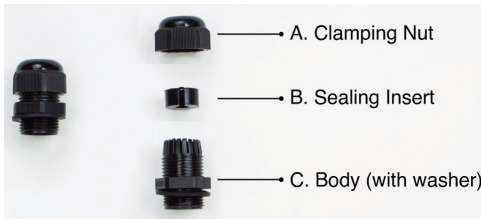

#### 3.2 Connecting Waterproof Cable Kit to the Outdoor PoE Injector

**Step 1:** Turn clockwise to tighten the **gland body** connected to the Outdoor PoE Injector.

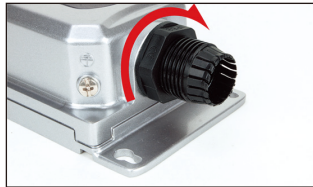

**Step 2:** Plug the power cable connector into the power input port.

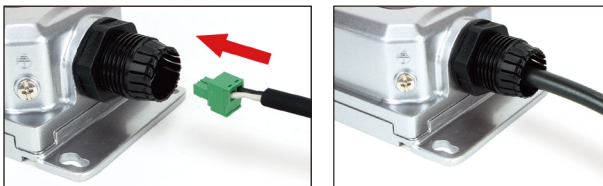

**Step 3:** Insert the **sealing insert** into the cable gland body.

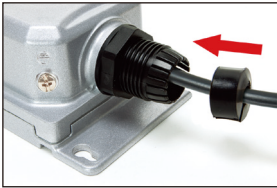

**Step 4:** Attach the **clamping nut** to the cable gland to complete the cable assembly.

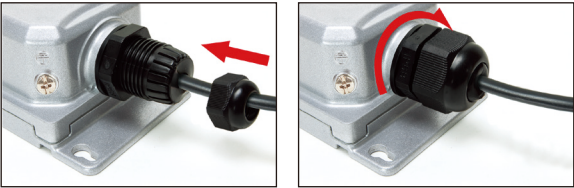

Caution

Make sure the clamping nut is tightly attached to the cable gland body and the sealing insert is squeezed tightly.

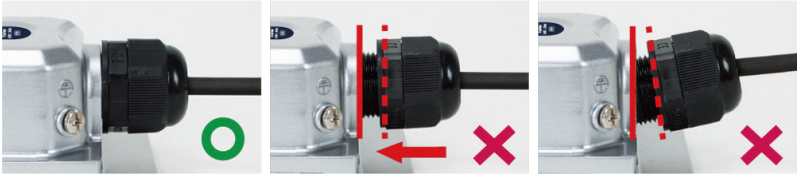

**Step 5:** Repeat **Steps 1 to 4** for "Data" Input Port and "PoE (Data + Power)" Output Port.

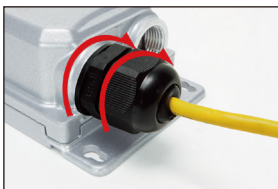

1. Use only the waterproof cable gland provided in the package of the IPOE-175.
2. If the above installation procedure is not properly followed, the warranty will be invalidated.
3. If the waterproof cable gland is found missing or damage, please contact your local reseller where you purchased from.



Note

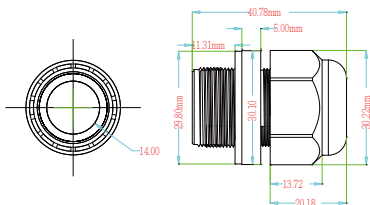

4. Never use any waterproof cable gland that is not purchased from PLANET or doesn't have the same dimensions of the IPOE-175; it will damage the device permanently.



### 3.3 Wall-mount Installation

To install the Outdoor PoE Injector on the wall, please follow the instructions described below.

**Step 1:** Find the wall that you want to mount the Outdoor PoE Injector on.

**Step 2:** Refer to the picture below to screw the four screws on the wall

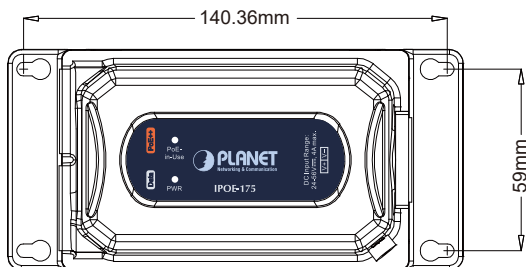

**Step3:** Use a screwdriver to screw them into the wall.



### 3.4 Connecting IPOE-175 to PD

Users **MUST** complete grounding wired with the device; otherwise, a sudden lightning could cause fatal damage to the device.

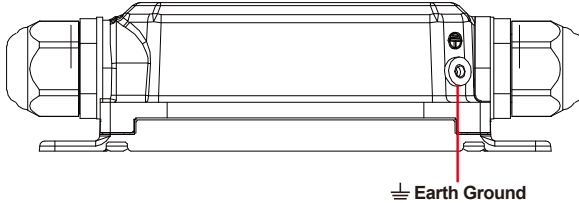

Note

EMD (Lightning) DAMAGE IS NOT COVERED UNDER WARRANTY.

### 3.5 Connecting IPOE-175 to PD

**Step 1:** Connect the additional Cat5e/6/6A cable from the **PoE++ Out** of the IPOE-175 to a remote **PD**.

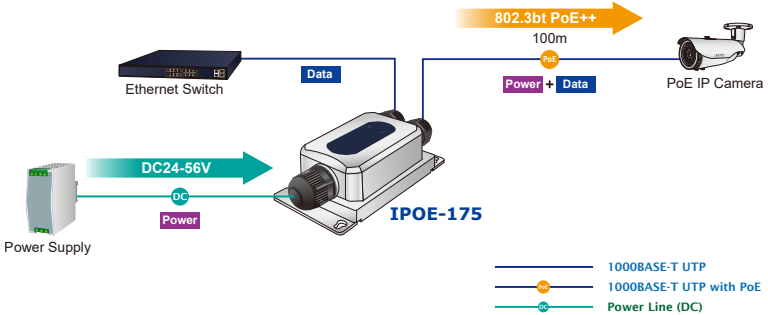

**Step 2:** The **PoE++ Out** port is the power injector which transmits DC voltage to the Cat5e/6/6A cable and transfer data from the Data source.

---

**Step 3:** Once the IPOE-175 detects the existence of an IEEE 802.3at/bt device or Ethernet device, the **LAN** LED indicator will be lit steadily, showing it is providing power.



Note

According to IEEE 802.3at/bt standard, the IPOE-175 will not inject power to the cable if not connected to a standard IEEE 802.3at/bt device.

## 4. Product Specifications

Product	IPOE-175		
Hardware Specifications			
Interface	Input Port	1 x 10/100/1000/2500BASE-T <b>"Data"</b> in RJ45 port	
	Output Port	1 x 10/100/1000/2500BASE-T Ethernet with IEEE 802.3bt PoE++ <b>"Data + DC" out</b> RJ45 port	
	Input Power Terminal Block	1 x 2-pin terminal block - Pin 1/2 for Power (Pin 1: V+ / Pin 2: V-)	
Data Rate	10/100/1000/2500Mbps		
LED Indicator	PWR (Green) PoE-in-Use x 1 (Amber)		
Input Voltage	24~56V DC		
Power Consumption	Voltage	System on	Full Load (Max.)
	DC 24V	1.2W	72W
	DC 48V	1.44W	70.56W
	DC 54V	1.71W	65.8W
ESD Protection	Air 8KV DC Contact 6KV DC		
Surge Protection	6KV		
Enclosure	IP67-rated and IK10 aluminum case		
Installation	Wall-mount ear		
Dimensions (W x D x H)	150 x 43.8 x 72.94 mm 169.85 x 43.8 x 72.94 mm, with cable gland		
Weight	485g		
MTBF	>100,000 hours		
Network Cable	10BASE-T: UTP category 3, 5 cable (≤100m) 100BASE-TX: UTP category 5, 5e cable (≤100m) 1000BASE-T: UTP category 5e, 6 cable (≤100m) 2500BASE-T: UTP category 5e, 6, 6A cable (≤100m)		

Power over Ethernet	
PoE Standard	IEEE 802.3bt PoE++ type 3 PSE Backward compatible with IEEE 802.3at PoE+
PoE Power Supply Type	802.3btEnd-span/Mid-span
PoE Power Output	55V DC Max. 60 watts to 802.3bt PoE++ PD Max. 30 watts to 802.3at PoE+ PD
Power Pin Assignment	802.3bt: 1/2 (-), 3/6 (+), 4/5 (+), 7/8 (-) End-span: 1/2 (-), 3/6 (+) Mid-span: 4/5 (+), 7/8 (-)
Standards Conformance	
Regulatory Compliance	FCC Part 15 Class A CE
Stability Testing	IEC 60068-2-32 (Free fall) IEC 60068-2-27 (Shock) IEC 60068-2-6 (Vibration)
Standard Conformances	IEEE 802.3 10BASE-T Ethernet IEEE 802.3u 100BASE-TX Fast Ethernet IEEE 802.3ab 1000BASE-T Gigabit Ethernet IEEE 802.3af Power over Ethernet IEEE 802.3at Power over Ethernet Plus IEEE 802.3bt Power over Ethernet Plus Plus
Environment	
Operating Temperature	-40 ~ 75 degrees C
Storage Temperature	-40 ~ 85 degrees C
Humidity	5 ~ 95% (non-condensing)



#### Note

The PoE power output ability will depend on the distance.

## ***Customer Support***

Thank you for purchasing PLANET products. You can browse our online FAQ resource and user's manual on PLANET web site first to check if it could solve your issue. If you need more support information, please contact PLANET support team.

PLANET online FAQs:

<https://www.planet.com.tw/en/support/faq>

Support team mail address:

[support@planet.com.tw](mailto:support@planet.com.tw)

Copyright © PLANET Technology Corp. 2022.

Contents are subject to revision without prior notice.

PLANET is a registered trademark of PLANET Technology Corp.

All other trademarks belong to their respective owners.