

**Industrial L3 5-Port 10GBASE-X SFP+ + 1-Port
10GBASE-T Managed Ethernet Switch**

IGS-6325-5X1T

Quick Installation Guide

Table of Contents

1. Package Contents	3
2. Requirements	4
3. Wiring the Power Inputs.....	5
3.1 Grounding the Device	6
4. Terminal Setup	7
4.1 Logging on to the Console.....	8
4.2 Configuring IP Address via Console	8
4.3 Storing the current switch configuration	10
5. Starting Web Management	11
5.1 Logging in to the Industrial Managed Switch.....	11
5.2 Saving Configuration via Web	14
6. Recovering Back to Default Configuration.....	15
7. Customer Support	16

1. Package Contents

Thank you for purchasing PLANET L3 Industrial Managed Switch, IGS-6325-5X1T. “**Industrial Managed Switch**” mentioned in this Quick Installation Guide refers to the above model.

Open the box of the **Industrial Managed Switch** and carefully unpack it. The box should contain the following items:

	IGS-6325-5X1T
The Industrial Managed Switch	■
DB9 to RJ45 Interface RS232 Console Cable	■
Quick Installation Guide	■
Wall Mounting Kit	■
RJ45 Dust Cap	2
SFP Dust Cap	5

If any of these are missing or damaged, please contact your dealer immediately. If possible, retain the carton including the original packing materials to enable you to repack the product in case there is a need to return it to us for repair.

2. Requirements

The Industrial Managed Switch provides remote login interface for management purposes. The following equipment is necessary for further management:

- **Workstations** running Windows XP/2003/2008/Vista/7/8/10/11, MAC OS X or later, Linux, UNIX, or other platforms are compatible with TCP/IP Protocols.
- Workstations are installed with Ethernet NIC (Network Interface Card).
- **Serial Port Connection** (Terminal)
 - The above Workstations come with **COM Port** (DB9) or USB-to-RS232 convertor.
 - The above Workstations have been installed with **terminal emulator**, such as Hyper Terminal included in Windows XP/2003, putty or tera term.
 - **Serial cable** -- one end is attached to the RS232 serial port, while the other end to the **console port** of the Industrial Managed Switch.
- **Ethernet Port Connection**
 - **Network cables** -- Use standard network (UTP) cables with RJ45 connectors.
 - The above PC is installed with **Web browser**.



Note

It is recommended to use Chrome 98.0.xxx or above to access the Industrial Managed Switch.

3. Wiring the Power Inputs

The Upper Panel of the **Industrial Managed Switch** indicates an inlet power socket and consists of one green terminal block connector within 6 contacts. Please follow the steps below to insert the power wire.

1. Insert positive/negative DC power wires into Contacts 1 and 2 for Power 1, or Contacts 5 and 6 for Power 2.

- DC 9-48V, AC 24V

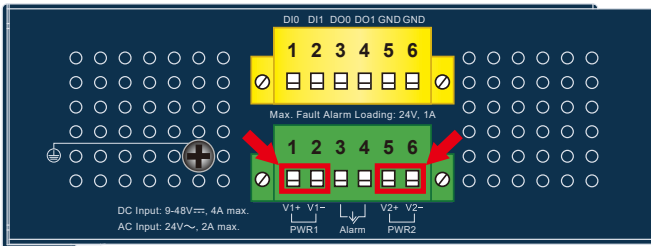

Figure 3-1: IGS-6325-5X1T Upper Panel

2. Tighten the wire-clamp screws for preventing the wires from loosening.

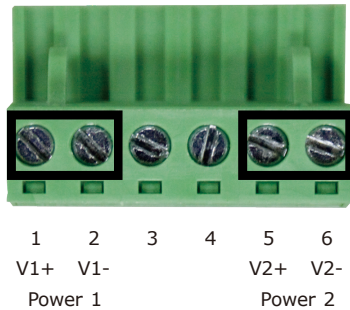

Figure 3-2: Power1 & 2 Pins of Terminal Block Connector



1. The wire gauge for the terminal block should be in the range from **12** to **24 AWG**.
2. Please check the AWG Ampere specification before connecting PLANET Industrial Managed Switch.

3.1 Grounding the Device

Users MUST complete grounding wired with the device; otherwise, a sudden lightning could cause fatal damage to the device.

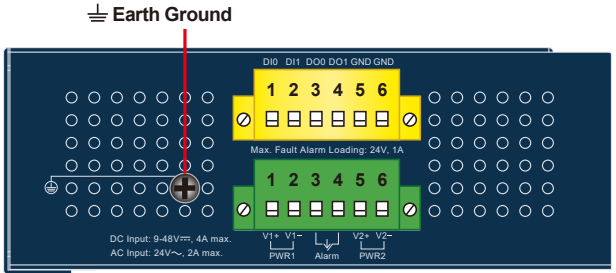

4. Terminal Setup

To configure the system, connect a serial cable to a **COM port** on a PC or notebook computer and to RJ45 type serial (console) port of the Industrial Managed Switch.

IGS Industrial Managed Switch



RJ45 to DB9 RS232 Cable

PC/Workstation with Terminal Emulation Software



A terminal program is required to make the software connected to the Industrial Managed Switch.

1. Run terminal program on the OS.
2. When the following screen appears, make sure that the COM port should be configured as:

- ◆ Baud: 115200
- ◆ Parity: None
- ◆ Data bits: 8
- ◆ Stop bits: 1
- ◆ Flow control: None

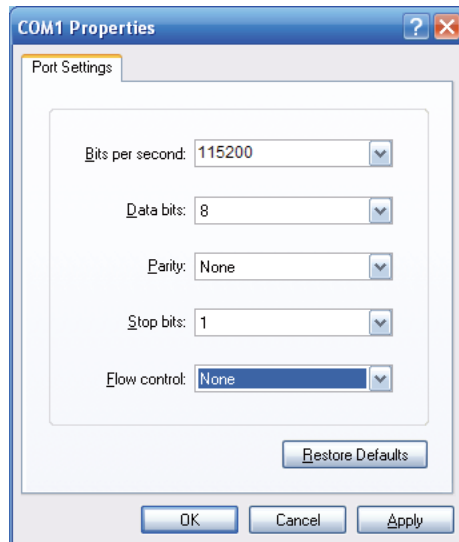

4.1 Logging on to the Console

Once the terminal has been connected to the device, power on the Industrial Managed Switch and the terminal will display “running testing procedures”.

Then, the following message asks to log in user name and password. The factory default user name and password are shown as follows as the login screen in Figure 4-1 appears.

Username: **admin**
Password: **admin**

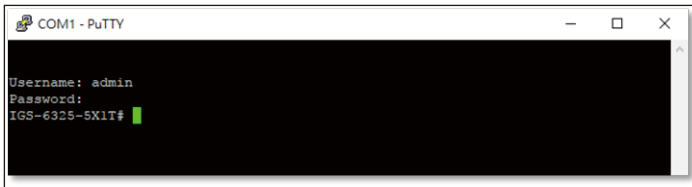

Figure 4-1: Console Login Screen

The user can now enter commands to manage the Industrial Managed Switch. For a detailed description of the commands, please refer to the following chapters.



Note

1. For security reason, **please change and memorize the new password after this first setup.**
2. Only accept command in lowercase letter under console interface.

4.2 Configuring IP Address via Console

The Industrial Managed Switch is shipped with default IP address shown below:

IP Address: **192.168.0.100**
Subnet Mask: **255.255.255.0**

To check the current IP address or modify a new IP address for the Switch, please use the procedure as follows:

■ Display of the Current IP Address

1. At the “#” prompt, enter “**show ip interface brief**”.

```
IGS-6325-Series # show ip interface brief
```

2. The screen displays the current IP address shown in Figure 4-2.

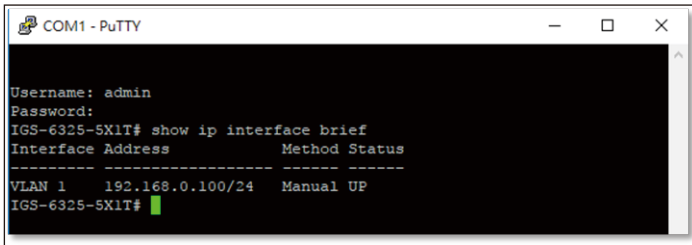

```
COM1 - PuTTY
Username: admin
Password:
IGS-6325-5X1T# show ip interface brief
Interface Address      Method Status
-----
VLAN 1    192.168.0.100/24    Manual UP
IGS-6325-5X1T#
```

Figure 4-2: IP Information Screen

■ Configuration of the IP Address

3. At the “#” prompt, enter the following command and press **<Enter>** as shown in Figure 4-3.

```
IGS-6325-Series# configure terminal
IGS-6325-Series (config)# interface vlan 1
IGS-6325-Series (config-if-vlan)# ip address 192.168.1.100 255.255.255.0
```

The previous command would apply the following settings for the Industrial Managed Switch.

```
IP Address: 192.168.1.100
Subnet Mask: 255.255.255.0
```

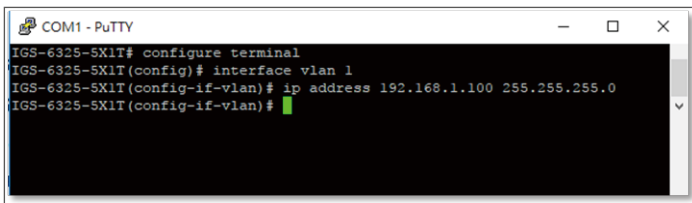

```
COM1 - PuTTY
IGS-6325-5X1T# configure terminal
IGS-6325-5X1T(config)# interface vlan 1
IGS-6325-5X1T(config-if-vlan)# ip address 192.168.1.100 255.255.255.0
IGS-6325-5X1T(config-if-vlan)#
```

Figure 4-3: Configuring IP Address Screen

4. Repeat step 1 to check if the IP address has changed.

4.3 Storing the current switch configuration

1. At the “#” prompt, enter the following command and press <Enter>.

```
# copy running-config startup-config
```



Figure 4-4: Saving Current Configuration Command Screen

If the IP is successfully configured, the Industrial Managed Switch will apply the new IP address setting immediately. You can access the Web interface of the Industrial Managed Switch through the new IP address.



Note

If you are not familiar with the console command or the related parameter, enter “**help**” anytime in console to get the help description.

5. Starting Web Management

The following shows how to start up the **Web Management** of the Industrial Managed Switch. Note the Industrial Managed Switch is configured through an Ethernet connection. Please make sure the manager PC must be set to the same **IP subnet address**.

For example, the default IP address of the Industrial Managed Switch is **192.168.0.100**, then the manager PC should be set to **192.168.0.x** (where x is a number between 1 and 254, except 100), and the default subnet mask is 255.255.255.0.

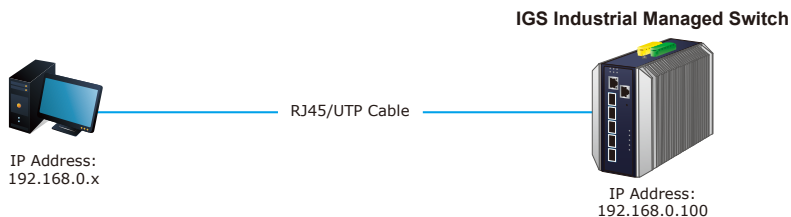

Figure 5-1: IP Management Diagram

5.1 Logging in to the Industrial Managed Switch

1. Use Chrome 98.0.xxx or above for Web browser and enter IP address **https://192.168.0.100** (the factory-default IP address) to access the Web interface.
2. When the following dialog box appears, please enter the default user name "**admin**" and password "**admin**" (or the password you have changed before) as shown in Figure 5-2.

Default IP Address: **192.168.0.100**
Default Username: **admin**
Default Password: **admin**

The screenshot shows a web browser's security warning dialog box. The title is "Authentication required". Below the title, it says "https://192.168.0.100" and "Your connection to this site is not private". There are two input fields: "Username" and "Password". At the bottom, there are two buttons: "Log in" and "Cancel".

Figure 5-2: Login Screen

3. After entering the password, the main screen appears as shown in Figure 5-3.

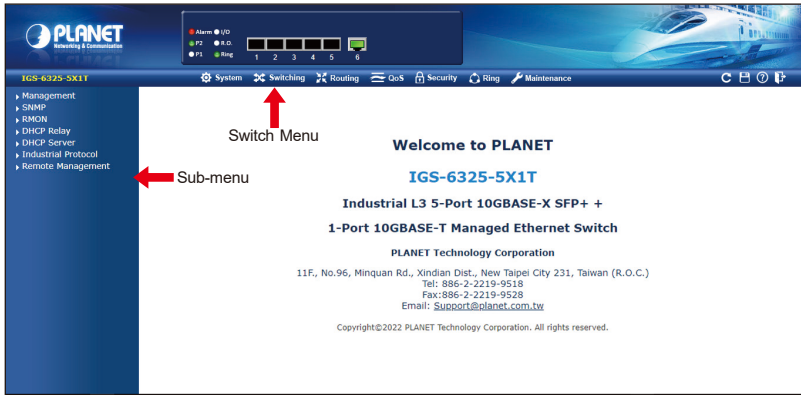

Figure 5-3: Web Main Screen of Industrial Managed Switch

The Switch Menu on the top of the Web page lets you access all the commands and statistics the Industrial Managed Switch provides. The Switch Menu always contains one or more buttons, such as **“System”**, **“Switching”**, **“Routing”**, **“QoS”**, **“Security”**, **“Ring”** and **“Maintenance”**.



Figure 5-4: Switch Menu



Figure 5-5: Switch Sub-menu



Figure 5-6: Switch Sub-menu

Now, you can use the Web management interface to continue the Switch management. Please refer to the user manual for more.



Note

If you are not familiar with Switch functions or the related parameter, press **"Help icon"** anytime on the Web page to get the help description.

5.2 Saving Configuration via Web

To save all applied changes and set the current configuration as a startup configuration, the startup-configuration file will be loaded automatically across a system reboot.

1. Click the **Save** icon on the top Switch Menu bar.

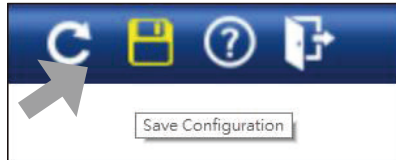

2. Press the "**Save Configuration**" button.

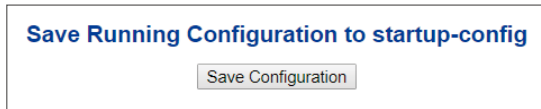

3. Or the other way to save the setting is to Click **Maintenance, Save Startup Config**.

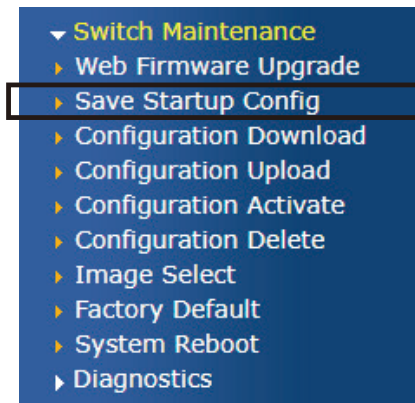

6. Recovering Back to Default Configuration

■ IP address has been changed or admin password has been forgotten –

To reset the IP address to the default IP address “**192.168.0.100**” and the user password to factory default mode (default password is **admin**), press the hardware-based **reset button** on the front panel for about **10 seconds**. After the device is rebooted, you can log in the management Web interface within the same subnet of 192.168.0.xx and default password. Be noted that all the previous setups will be disappeared after the factory default reset is made.

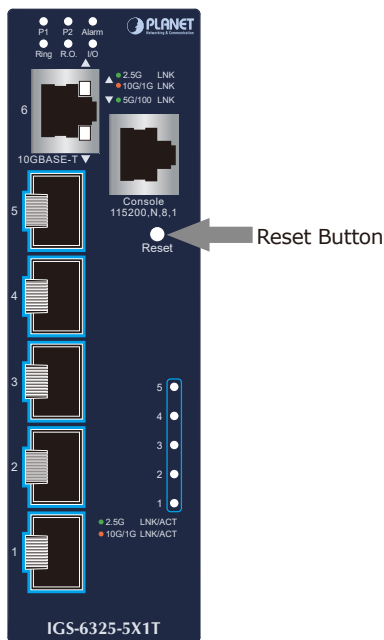

Figure 6-1: IGS-6325-5X1T Reset Button

7. Customer Support

Thank you for purchasing PLANET products. You can browse our online FAQ resource on PLANET web site first to check if it could solve your issue. If you need more support information, please contact PLANET switch support team.

PLANET online FAQs:

<https://www.planet.com.tw/en/support/faq>

Switch support team mail address:

support@planet.com.tw

Industrial User's Manual:

<https://www.planet.com.tw/en/support/downloads?&method=keyword&keyword=IGS-6325&view=3#list>



(Please select your switch model name from the Product Model drop-down menu)

Copyright © PLANET Technology Corp. 2022.

Contents are subject to revision without prior notice.

PLANET is a registered trademark of PLANET Technology Corp.

All other trademarks belong to their respective owners.