

**8-/16-/24-/48-Port 10/100/1000T +
2-/4-Port 100/1000X SFP Managed Switch**

GS-4210 Series

Quick Installation Guide

Table of Contents

1. Package Contents	3
2. Requirements	5
3. Terminal Setup	6
3.1 Logging on to the Console.....	7
3.2 Configuring IP Address via the Console	7
3.3 Storing Current Switch Configuration.....	9
4. Starting Web Management	10
4.1 Logging in to the Managed Switch	10
4.2 Saving Configuration via the Web	13
5. Recovering Back to Default Configuration.....	14
6. Customer Support	16

1. Package Contents

Thank you for purchasing PLANET GS-4210 Managed Switch series. The descriptions of this series are shown below:

Model	Description
GS-4210-8T2S	8-Port 10/100/1000T + 2-Port 100/1000X SFP Managed Switch
GS-4210-8P2S	8-Port 10/100/1000T 802.3at PoE + 2-Port 100/1000X SFP Managed Switch
GS-4210-8P2C	8-Port 10/100/1000T 802.3at PoE + 2-Port 10/100/1000T +2-Port 100/1000X SFP Managed Switch
GS-4210-16T2S	16-Port Layer 2 Managed Gigabit Ethernet Switch w/2 SFP Interfaces
GS-4210-16P2S	16-Port 10/100/1000T 802.3at PoE + 2-Port 100/1000X SFP Managed Switch
GS-4210-24T2S	24-Port Layer 2 Managed Gigabit Ethernet Switch w/2 SFP Interfaces
GS-4210-24P2S	24-Port 10/100/1000T 802.3at PoE + 2-Port 100/1000X SFP Managed Switch
GS-4210-24T4S	24-Port 10/100/1000T + 4-Port 100/1000X SFP Managed Gigabit Switch
GS-4210-24T4SR	24-Port 10/100/1000T + 4-Port 100/1000X SFP Managed Gigabit Switch with 36-72V DC Redundant Power
GS-4210-48T4S	48-Port Layer 2 Managed Gigabit Ethernet Switch w/4 SFP Interfaces

“Managed Switch” is used as an alternative name in this Quick Installation Guide.

Open the box of the Managed Switch and carefully unpack it. The box should contain the following items:

- The Managed Switch x 1
- Quick Installation Guide x 1
- RS232 to RJ45 Cable x 1
- Rubber Feet x 4
- Two Rack-mounting Brackets with Attachment Screws x 1
- Power Cord x 1
- SFP Dust-proof Cap

	SFP Dust-proof Caps
GS-4210-8P2C GS-4210-8T2S GS-4210-8P2S	2
GS-4210-16T2S GS-4210-16P2S	2
GS-4210-24T2S GS-4210-24P2S	2
GS-4210-24T4S GS-4210-24T4SR GS-4210-48T4S	4

If any item is found missing or damaged, please contact your local reseller for replacement.

2. Requirements

- Workstations running Windows XP/2003/2008/2012/Vista/7/8/10, MAC OS X or later, Linux, UNIX, or other platforms are compatible with TCP/IP protocols.
- Workstations are installed with Ethernet NIC (Network Interface Card).
- **Serial Port Connection** (Terminal)
 - The above Workstations come with COM Port (DB9) or USB-to-RS-232 converter.
 - The above Workstations have been installed with **terminal emulator**, such as Tera Term, PuTTY or Hyper Terminal included in Windows XP/2003.
 - Serial cable -- one end is attached to the RS-232 serial port, while the other end to the console port of the Managed Switch.
- **Ethernet Port Connection**
 - Network cables -- Use standard network (UTP) cables with RJ45 connectors.
 - The above PC is installed with Web browser.



Note

It is recommended to use Internet Explorer 8.0 or above to access the Managed Switch. If the Web interface of the Managed Switch is not accessible, please turn off the anti-virus software or firewall and then try it again.

3. Terminal Setup

To configure the system, connect a serial cable to a **COM port** on a PC or notebook computer while the other end to RJ45 console port of the Managed Switch.

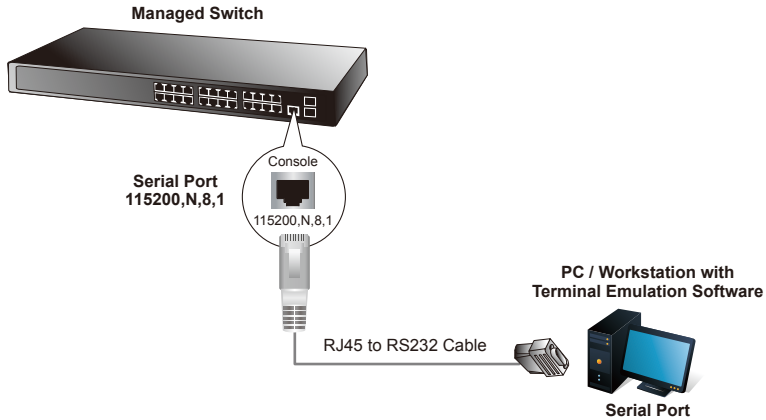

Figure 3-1: Managed Switch Console Connectivity

A terminal program is required to make the software connection to the Managed Switch.

1. Run terminal program on the OS.
2. When the following screen appears, make sure that the COM port should be configured as:

- ◆ Baud: 115200
- ◆ Data bits: 8
- ◆ Parity: None
- ◆ Stop bits: 1
- ◆ Flow control: None

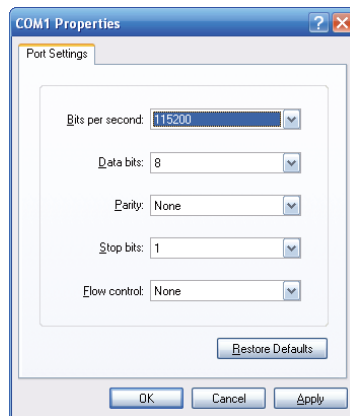

Figure 3-2: COM Port Configuration

3.1 Logging on to the Console

Once the terminal is connected to the device, power on the Managed Switch and the terminal will **run self testing procedures**. Then, the following message asks to log in user name and password. The factory default user name and password are shown as follows and the login screen in Figure 3-3 appears.

Username: **admin**
Password: **admin**



Note

The following console screen based on the GS-4210-24T4S is the same as those of other GS-4210 series.

```
Press any key to continue
Username: admin
Password: *****
GS-4210-24T4S#
```

Figure 3-3: Managed Switch Console Login Screen

The user can now enter commands to manage the Managed Switch. For a detailed description of the commands, please refer to the following chapters.



Note

1. For security reason, please change and memorize the new password after this first setup.
2. Only accept command in lowercase letter under console interface.

3.2 Configuring IP Address via the Console

The Managed Switch is shipped with default IP address as shown below:

IP Address: **192.168.0.100**
Subnet Mask: **255.255.255.0**

To check the current IP address or modify a new IP address for the Managed Switch, please use the procedures as follows:

■ Display of the current IP address

1. On "GS-4210-24T4S#" prompt, enter "show ip".
2. The screen displays the current IP address, subnet mask and gateway shown in Figure 3-4.

```
Press any key to continue
Username: admin
Password: ****
GS-4210-24T4S# show ip
IP Address: 192.168.0.100
Subnet Netmask: 255.255.255.0
Default Gateway: 192.168.0.254
GS-4210-24T4S#
```

Figure 3-4: IP Information Screen

■ Configuration of the IP address

3. On "GS-4210-24T4S#" prompt, enter "configure".
4. On "GS-4210-24T4S (config)#" prompt, enter the following command and press <Enter> as shown in Figure 3-5.

```
GS-4210-24T4S (config)# ip address 192.168.1.100 mask 255.255.255.0
GS-4210-24T4S (config)# ip default-gateway 192.168.1.254
```

The previous command would apply the following settings for the Managed Switch.

IP Address: 192.168.1.100
Subnet Mask: 255.255.255.0
Gateway: 192.168.1.254

```
Press any key to continue
Username: admin
Password: ****
GS-4210-24T4S# configure
GS-4210-24T4S(config)# ip address 192.168.1.100 mask 255.255.255.0
GS-4210-24T4S(config)# ip default-gateway 192.168.1.254
GS-4210-24T4S(config)#
```

Figure 3-5: Setting IP Address Screen

5. Repeat Step 1 to check if the IP address has changed.

If the IP is successfully configured, the Managed Switch will apply the new IP address setting immediately. You can access the Web interface of Managed Switch through the new IP address.



Note

If you are not familiar with console command or the related parameter, enter "?" anytime in console to get the help description.

3.3 Storing Current Switch Configuration

In switches, the running configuration file is stored in the RAM. In the current version, the running configuration sequence can be saved from the RAM to FLASH by **saving** command or **copying running-config startup-config** command, so that the running configuration sequence becomes the startup configuration file, which is called configuration save.

1. On "GS-4210-24T4S #" prompt, enter "copy running-config startup-config" as shown in **Figure 3-6**.

```
Press any key to continue
Username: admin
Password: *****
GS-4210-24T4S# copy running-config startup-config
Success
GS-4210-24T4S#
```

Figure 3-6: Saving the Configuration Screen

4. Starting Web Management

The following shows how to start up the **Web Management** of the Managed Switch. Note the Managed Switch is configured through an Ethernet connection. Please make sure the manager PC must be set to the same **IP subnet address**.

For example, the default IP address of the Managed Switch is **192.168.0.100**; then the manager PC should be set to **192.168.0.x** (where x is a number between 1 and 254, except 100) and the default subnet mask is 255.255.255.0.

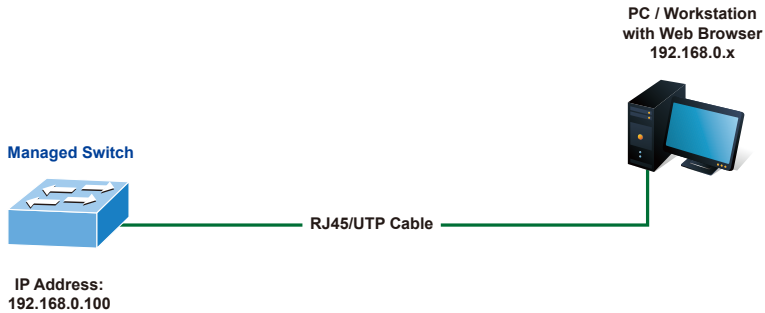

Figure 4-1: IP Management Diagram

4.1 Logging in to the Managed Switch

1. Use Internet Explorer 8.0 or above Web browser and enter IP address **<https://192.168.0.100>** to access the Web interface.
2. When the following dialog box appears, please enter the default user name and password "**admin**". The login screen in Figure 4-2 appears.

Default IP address: **192.168.0.100**
Default Username: **admin**
Default Password: **admin**



Figure 4-2: Web Login Screen



Note

1. The following web screen based on the GS-4210-24T4S is the same as those of the GS-4210 series.
2. The PoE function is only available for GS-4210-8P2C, GS-4210-8P2S, GS-4210-16P2S and GS-4210-24P2S.

3. After entering the password, the main screen appears as Figure 4-3 shows.



Figure 4-3: Web Main Screen of Managed Switch

The Switch Menu on the left of the Web page lets you access all the commands and statistics the Managed Switch provides.



Figure 4-4: Switch Menu

Now, you can use the Web management interface to continue the switch management. Please refer to the user's manual for more.

4.2 Saving Configuration via the Web

Save all applied changes and set the current configuration as a startup configuration. The startup-configuration file will be loaded automatically across a system reboot.

1. Click **"SAVE > Save Configurations to FLASH"** to log in "Configuration Manager" Page.

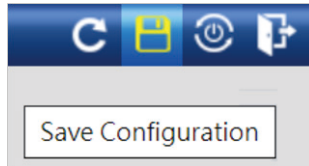

2. Press the **"Apply"** button to save running configuration as startup configuration.

Configuration Manager	
Save Configuration	
Source File	<input checked="" type="radio"/> Running configuration <input type="radio"/> Startup configuration <input type="radio"/> Backup configuration
Destination File	<input checked="" type="radio"/> Startup configuration <input type="radio"/> Backup configuration
<input type="button" value="Apply"/>	

5. Recovering Back to Default Configuration

■ IP address has been changed or admin password has been forgotten –

To reset the IP address to the default IP address **"192.168.0.100"** or reset the login password to default value, press the **reset button** on the front panel for about **10 seconds**. After the device is rebooted, you can log in the Web interface management within the same subnet of 192.168.0.xx.

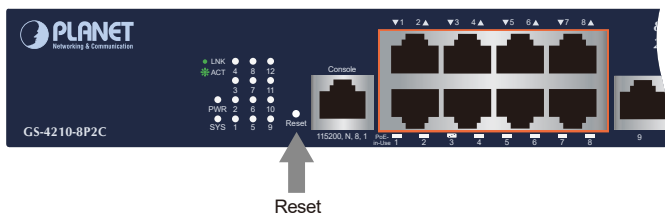

Figure 5-1: GS-4210-8P2C Reset Button

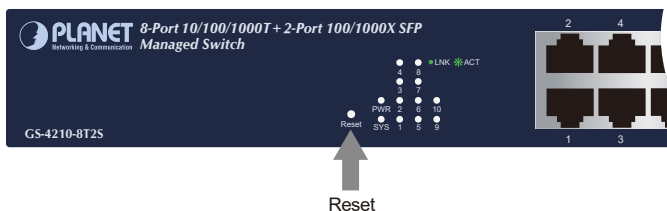

Figure 5-2: GS-4210-8T2S Reset Button

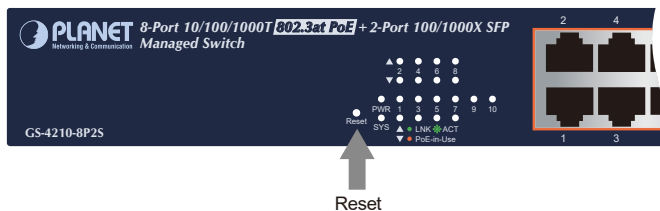

Figure 5-3: GS-4210-8P2S Reset Button

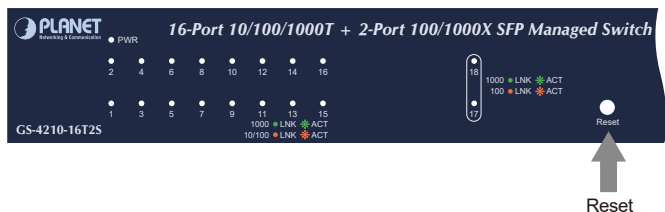

Figure 5-4: GS-4210-16T2S Reset Button

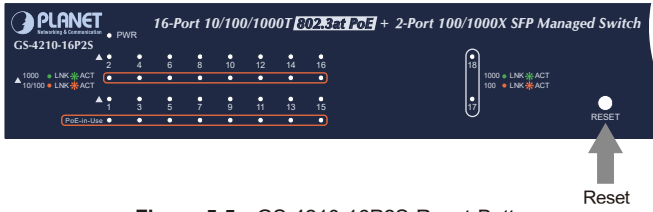

Figure 5-5: GS-4210-16P2S Reset Button



Figure 5-6: GS-4210-24T2S Reset Button

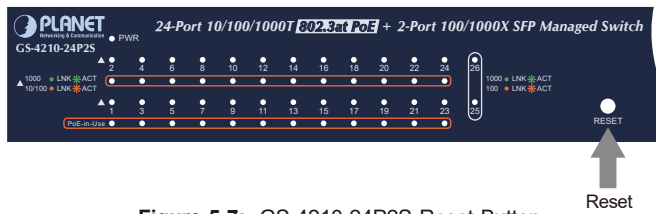

Figure 5-7: GS-4210-24P2S Reset Button

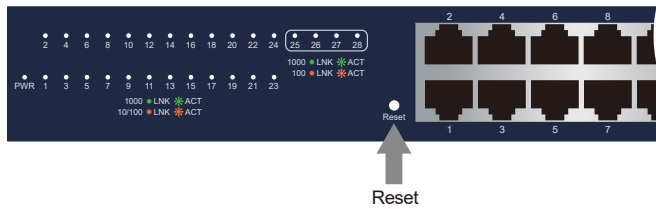

Figure 5-8: GS-4210-24T4S/GS-4210-24T4SR Reset Button

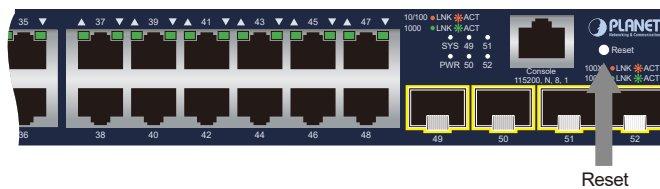

Figure 5-9: GS-4210-48T4S Reset Button

6. Customer Support

Thank you for purchasing PLANET products. You can browse our online FAQ resource and User's Manual on PLANET Web site first to check if it could solve your issue. If you need more support information, please contact PLANET switch support team.

PLANET online FAQs:

<http://www.planet.com.tw/en/support/faq>

Switch support team mail address:

support@planet.com.tw

GS-4210 Series User's Manual:

<https://www.planet.com.tw/en/support/downloads?&method=keyword&keyword=GS-4210&view=3#list>



Copyright © PLANET Technology Corp. 2021.

Contents are subject to revision without prior notice.

PLANET is a registered trademark of PLANET Technology Corp.

All other trademarks belong to their respective owners.