

**Dual Band 802.11ac 1200Mbps Wave 2  
Outdoor Wireless AP**

**WDAP-850AC**





Quick Installation Guide

# Table of Contents

1. Package Contents .....	3
2. Physical Introduction .....	4
3. Hardware Installation .....	5
4. Web Login.....	7
Further Information: .....	10

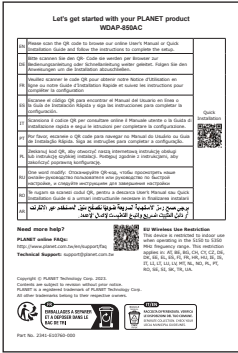
# 1. Package Contents

Thank you for choosing PLANET Outdoor Wireless AP. Before installing, please verify the contents inside the package box. The device mentioned herein is the brief name of the "Outdoor Wireless AP".

<p>WDAP-850AC</p>	<p>Quick Guide x 1</p>	<p>RJ45 Waterproof Kit x 1</p>
		
<p>L-type Bracket x 1</p>	<p>U-bolt Kit x 2</p>	<p>Screw Set x 1</p>
		



If there is any item missing or damaged, please contact the seller immediately.

**Note**



**IMPORTANT SAFETY PRECAUTIONS:**

- 1) **LIVES MAY BE AT RISK!** Please be aware of the electrical wires around. Carefully read the section "**OUTDOOR INSTALLATION WARNING**" in the manual before installation.
- 2) Users **MUST complete grounding wired** with the device; otherwise, a sudden lightning could cause fatal damage to the device. **EMD (Lightning) DAMAGE IS NOT COVERED UNDER WARRANTY.**
- 3) Users **MUST** power off the device first before connecting the antenna to it; otherwise, damage might be caused to the device itself.
- 4) The Antenna and Surge Arrestor are required for each antenna connector, and must be purchased separately.

**Caution**

## 2. Physical Introduction

### Hardware Description

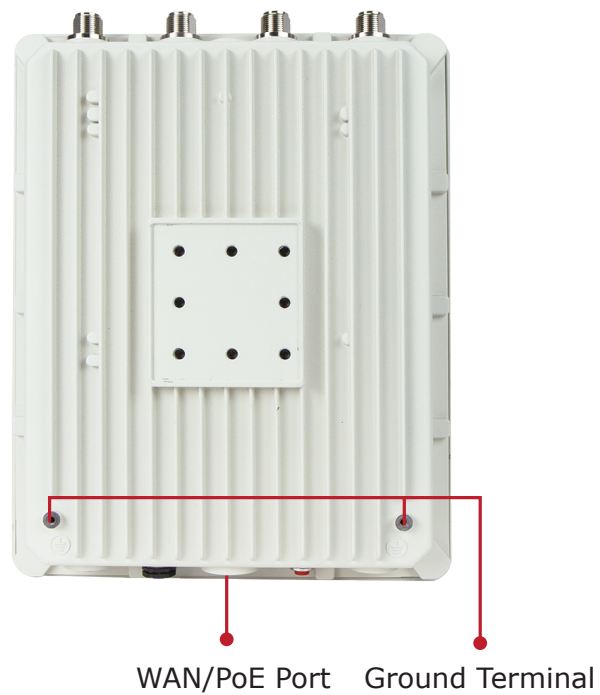
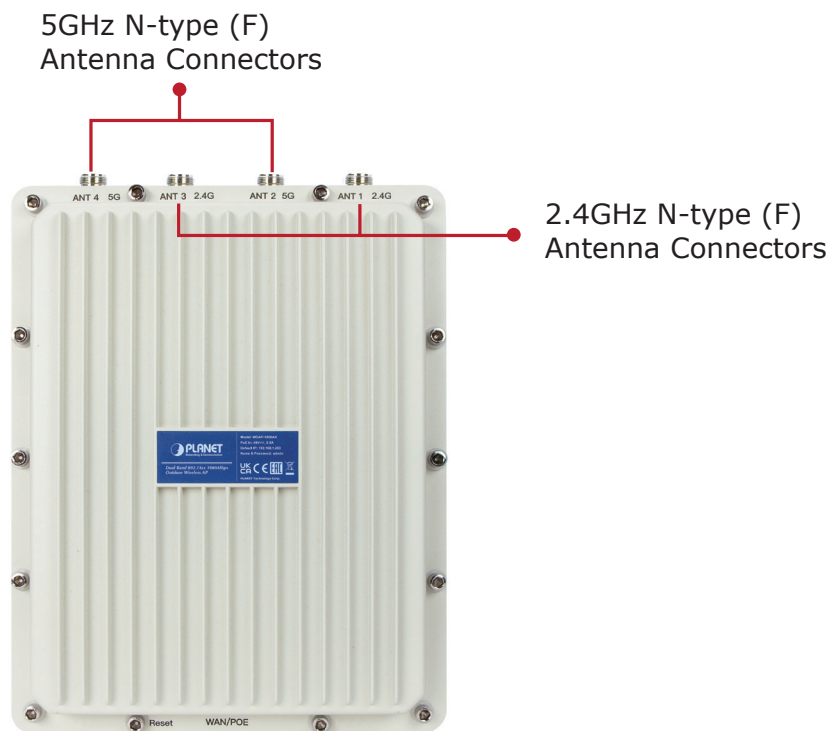

### 3. Hardware Installation

#### Step 1:

1. Install the backplane to the back of the AP.
2. Attach the L-type bracket to the backplane and fasten it.
3. Place the AP to the pole and fasten it with the U-bolt kit.

The AP can be mounted on the pole with a diameter of up to 2".

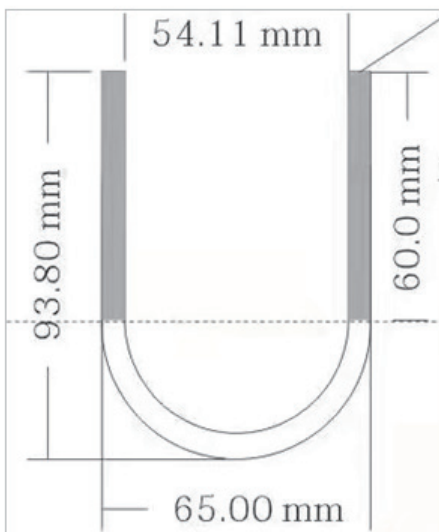
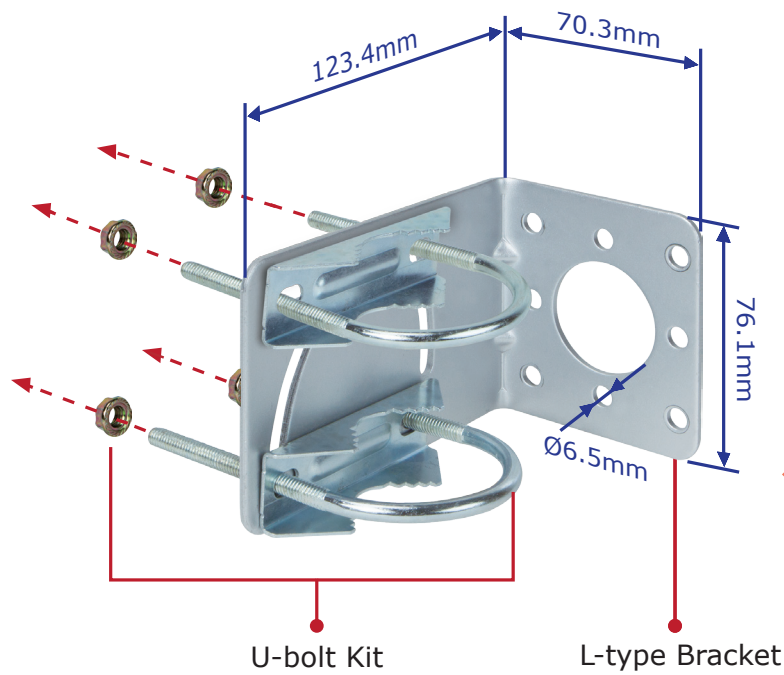

U-bolt Dimensions

## Step 2:

1. Attach the surge arrestors to each antenna connector.
2. Attach the antenna equipped with N-type (M) connector to each surge arrestor. Otherwise, connect the antenna through the N-male (male pin) to N-male (male pin) cable.
3. Plug the RJ45 Ethernet cable into the PoE port of the AP through the waterproof kit, and plug the other side of the RJ45 cable into the PoE port of the PoE switch to finish the installation.



Note

Please remember to finish grounding by consulting the local electrical experts.

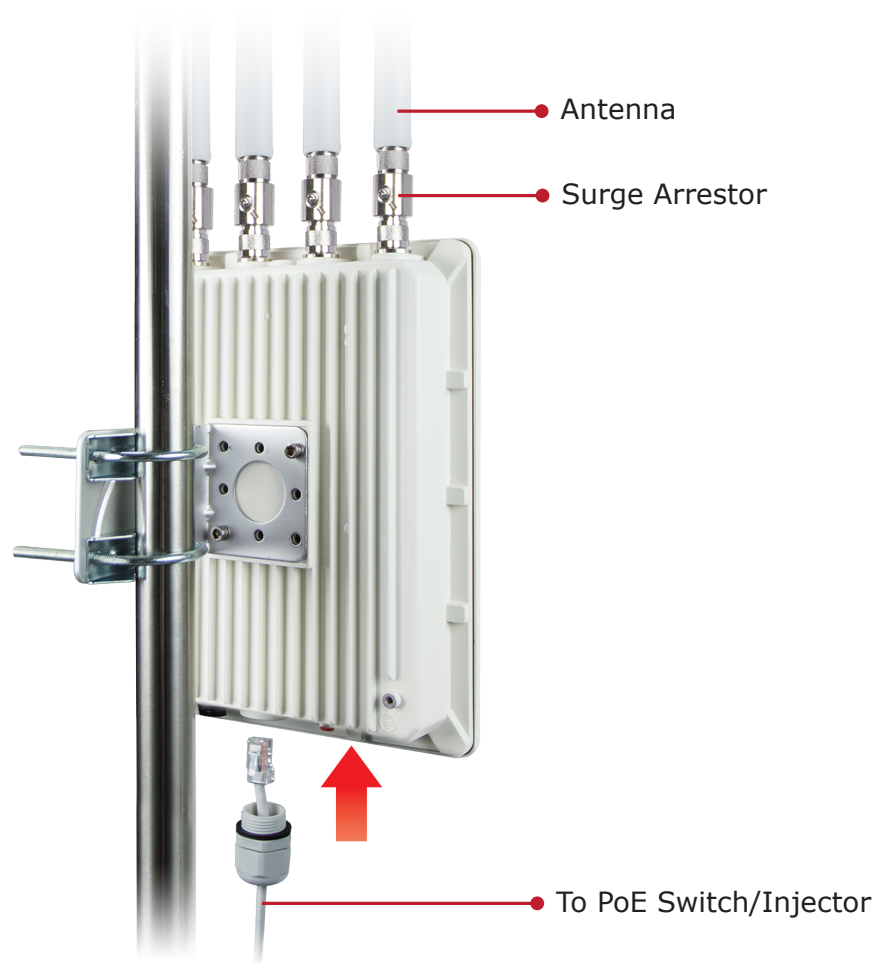

## 4. Web Login

A computer with wired Ethernet connection is required for the first-time configuration of the device.

1. Click the **"Start"** button located in the lower-left corner of your computer.
2. Click **"Control Panel"**.
3. Double-click the **"Network and Sharing Center"** icon.
4. Click **"Change Adapter Settings"**.
5. Double-click **"Local Area Connection"**.
6. Select **"Internet Protocol Version 4 (TCP/IPv4)"** and click **"Properties"**.
7. Select **"Use the following IP address"** and then click the **"OK"** button twice to save the configuration. For example, you may choose from 192.168.1.1 to 192.168.1.254 excluding the default IP address of the device (192.168.1.253).

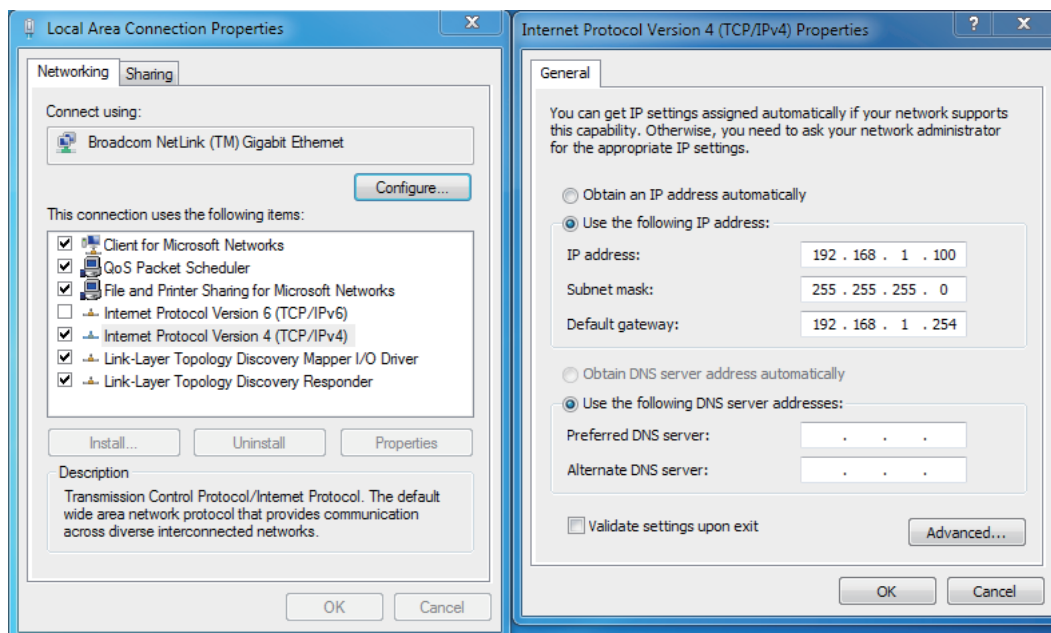

Default IP Address: **192.168.1.253**  
Default Password: **admin**  
Default 2.4GHz SSID: **PLANET\_2.4G**  
Default 5GHz SSID: **PLANET\_5G**

**Step 1:** The Web management allows you to access and manage the device easily. Launch the Web browser and enter the default IP address **http://192.168.1.253**.

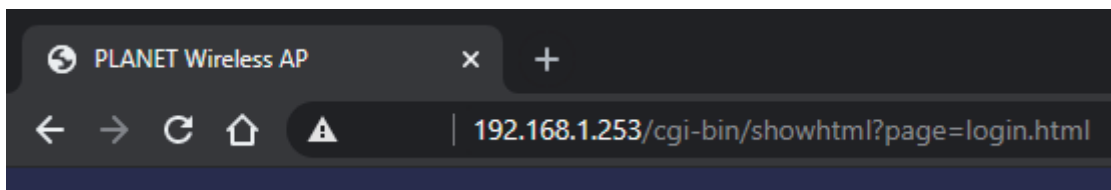

**Step 2:** Steps 2 and 3 are based on the firmware version before July 2024. When the login window appears, please enter the password. The default password is "admin". Then click the Login button to continue.

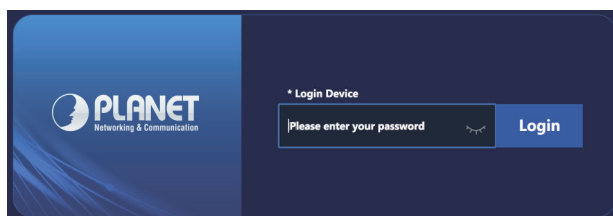

For security reasons, it is recommended to change the password at the first login and memorize it.

**Step 3:** For security reasons, it is strongly recommended to go to **Managed** to configure the Encryption Method and Passphrase of your wireless network.

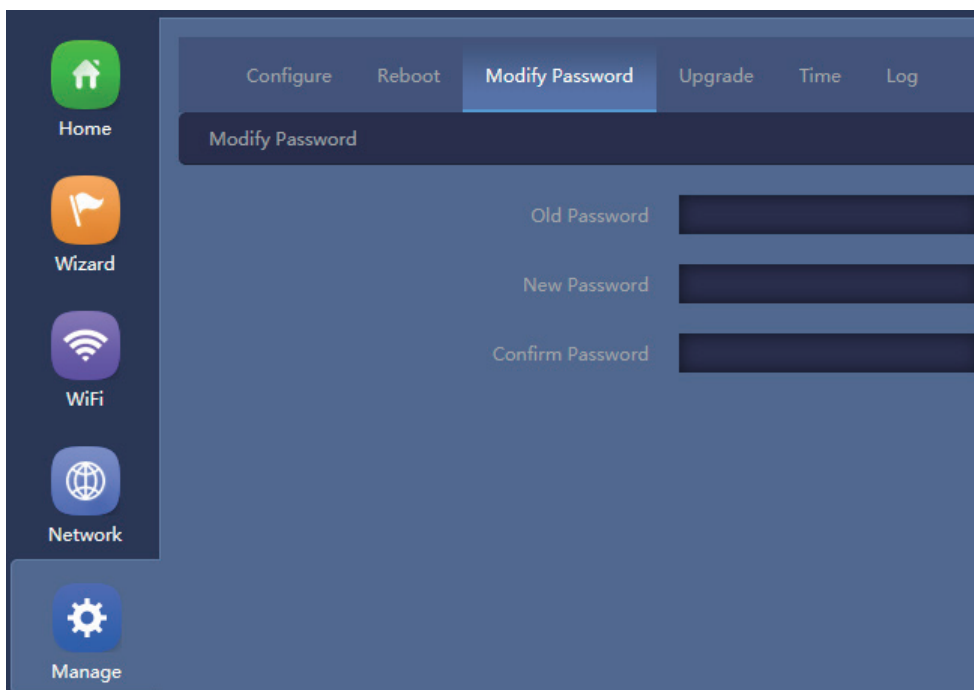





### Note

The web screen is based on the firmware version after July 2024. When the webpage displays the following message, please set the password according to the rules below. The Password must contain 8 to 32 characters, including uppercase, lowercase, numerals and other symbols. Only these 5 symbols, such as @, #, \*, \_ and -, can be accepted. Please note spaces (blanks) are not accepted. Then click the Apply button to continue.

## Initialization

Change the device management password at the first login

New Password

Confirm Password

The Password must contain at least 8 characters (Max. 32 characters), including upper case, lower case, numerals, and other symbols only this 5 character @, #, \*, \_ and - can be accepted.

## ***Further Information:***

The above steps introduce the simple installations and configurations of the device. For further configurations, please refer to the user manual, which can be downloaded from the website.

### **WDAP-850AC:**

<https://www.planet.com.tw/en/support/downloads?&method=keyword&keyword=WDAP-850AC&view=3#list>



If you have further questions, please contact the local dealer or distributor where you purchased this product.