







1. Package Contents

Thank you for purchasing PLANET Industrial IP67 802.3bt PoE++ Splitter, IPOE-175S. In the following sections, the term "Outdoor PoE Splitter" means the IPOE-175S.

Open the box of the IPOE-175S and carefully unpack it. The box should contain the following items:

| | | |
|--|---|---|
| IPOE-175S x 1 | User's Manual x 1 | M22 Waterproof Cable Gland x 3 |
|  |  |  |
| Power Cable with 2-pin Terminal Block x 1 | Wall-mounted Kit x 1 | Ground Wire x 1 |
|  |  |  |

If any of these are missing or damaged, please contact your dealer immediately; if possible, retain the carton including the original packing material, and use them again to repack the product in case there is a need to return it to us for repair.

2. Hardware Introduction

This section describes the functionalities of the Outdoor PoE Splitter's components.

2.1 Product Outlook

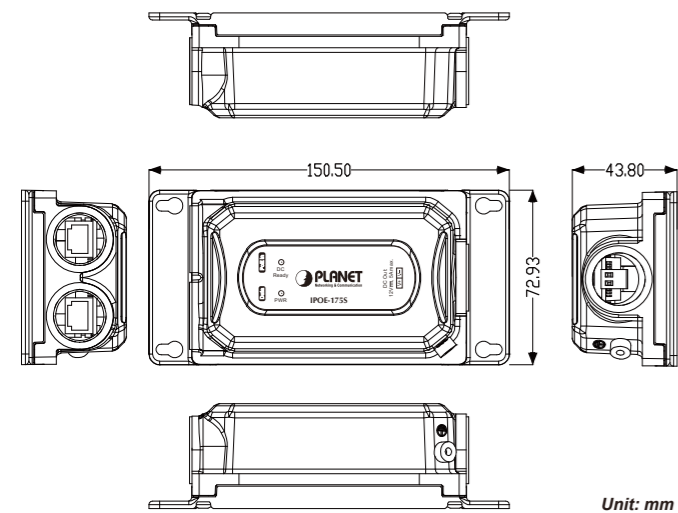

Figure 2-1: IPOE-175S product outlook

2.2 Power Input Port

Figure 2-2 shows the Power Output port side of the IPOE-175S

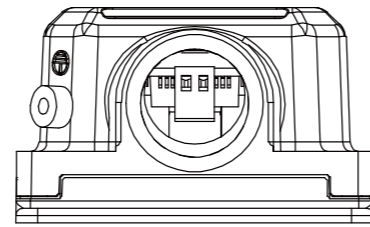

Figure 2-2: Power Output Port

2.3 802.3bt PoE++ Input Port and Data Output Port

Figure 2-3 shows the Date + PoE++ Input Port and Data Output Port side of the IPOE-175S.

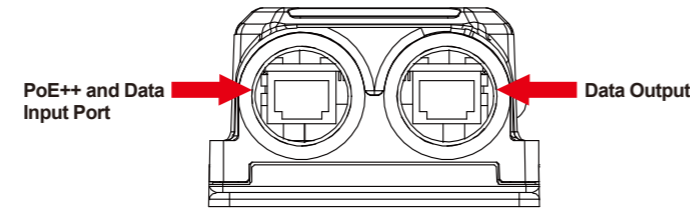

Figure 2-3: Two RJ45 Ports

2.4 LED Indicators

| LED | Color | Function |
|----------|-------|---|
| PWR | Green | Indicates it has power. |
| DC Ready | Green | Indicates the port is providing 12V DC in-line power. |

To install the 2-pin Terminal Block Connector on the **Outdoor PoE Splitter**, simply follow the following steps:

Step 1: Insert positive DC power wire into **V+**, negative DC power wire into **V-**, and grounding wire into **Ground**.

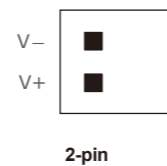

Step 2: Tighten the wire-clamp screws for preventing the wires from loosening and plug them into the Outdoor PoE Splitter

Note

1. The wire gauge should be in the range from 20 to 22 AWG.
2. The device must be grounded.

3. Installation

This section describes how to install the Outdoor PoE Splitter and make connections to it. Please read the following topics and perform the procedure in the order being presented.

3.1 Installing Cable Gland with Power Cable and RJ45 UTP Cable

The cable gland consists of the following:

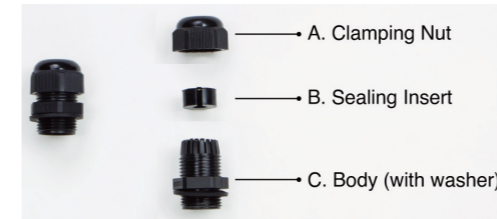

3.2 Connecting Waterproof Cable Kit to the Outdoor PoE Splitter

Step 1: Turn clockwise to tighten the **gland body** connected to the Outdoor PoE Splitter.



Step 2: Plug the power cable connector into the power output port.

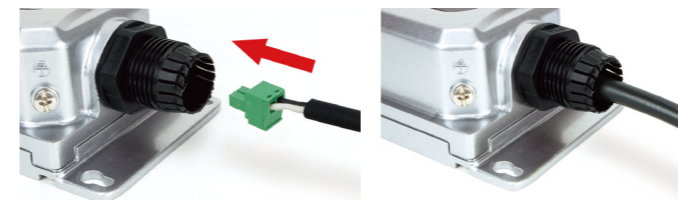

Step 3: Insert the **sealing insert** into the cable gland body.

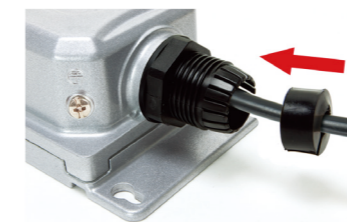

Step 4: Attach the **clamping nut** to the cable gland to complete the cable assembly.

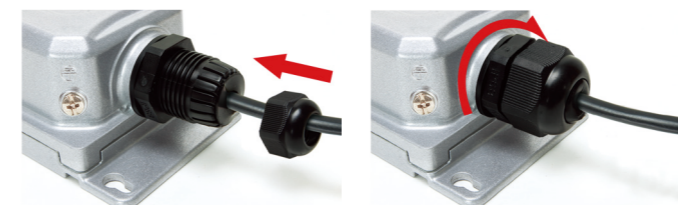

Make sure the clamping nut is tightly attached to the cable gland body and the sealing insert is squeezed tightly.

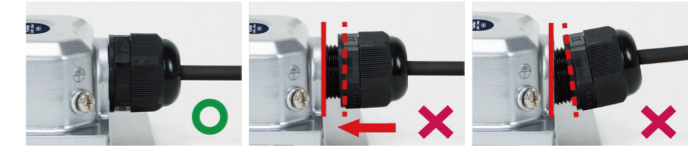

Step 5: Repeat **Steps 1 to 4** for "Data" output Port and "PoE (Data + Power)" input Port.

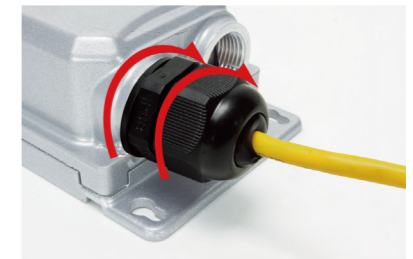

1. Use only the waterproof cable gland provided in the package of the IPOE-175S.
2. If the above installation procedure is not properly followed, the warranty will be invalidated.
3. I the waterproof cable gland is found missing or damage, please contact your local reseller where you purchased from.

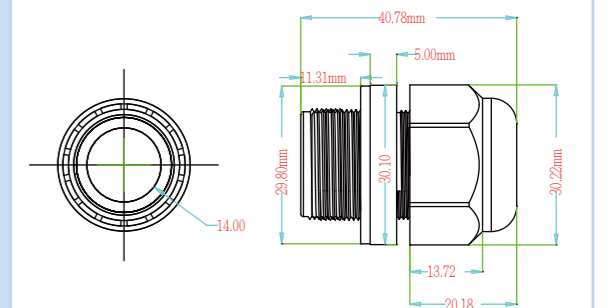
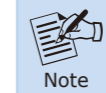

4. Never use any waterproof cable gland that is not purchased from PLANET or doesn't have the same dimensions of the IPOE-175S; it will damage the device permanently.

3.3 Wall-mount Installation

To install the Outdoor PoE Splitter on the wall, please follow the instructions described below.

Step 1: Find the wall that you want to mount the Outdoor PoE Splitter on.

Step 2: Refer to the picture below to screw the four screws on the wall.

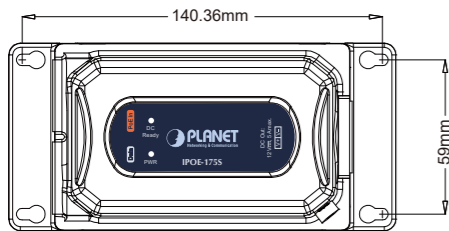

Step 3: Use a screwdriver to screw them into the wall.



3.4 Grounding the Device

Users **MUST** complete grounding wired with the device; otherwise, a sudden lightning could cause fatal damage to the device.



- 9 -

4. Product Specifications

| | | |
|-------------------------|--|---|
| Product | IPOE-175S | |
| Hardware Specifications | | |
| Interface | Input Port | 1 x 10/100/1000BASE-T Ethernet with IEEE 802.3bt PoE++ "PoE + Data" in RJ45 port |
| | Output Port | 1 x 10/100/1000BASE-T "Data" out RJ45 port |
| | Output Power Terminal Block | 1 x 2-pin terminal block "DC" out port - Pin 1/2 for Power (Pin 1: V+ / Pin 2: V-) |
| Data Rate | 10/100/1000Mbps | |
| LED Indicator | PWR (Green) DC Ready x 1 (Green) | |
| Input Voltage | 44~56V DC | |
| Power Requirement | 4-pair 802.3at PoE+ and 802.3bt PoE++: 52~56V DC 802.3at PoE+: 48~56V DC | |
| Power Consumption | Ethernet full loading without DC output: Full loading with maximum 12V DC, 5A output: 70watts | |
| ESD Protection | Air 8KV DC Contact 6KV DC | |
| Surge Protection | 6KV | |
| Enclosure | IP67-rated and IK10 aluminum case | |
| Installation | Wall-mount ear | |

- 11 -



User's Manual

www.PLANET.com.tw

Industrial IP67 802.3bt PoE++ Splitter

IPOE-175S



PLANET Technology Corp.

10F., No. 96, Minquan Rd., Xindian Dist., New Taipei City 231, Taiwan

Warning:
This device is compliant with Class A of CISPR 32.
In a residential environment this device may cause radio interference.
2351-AH8110-000



EMD (Lightning) DAMAGE IS NOT COVERED UNDER WARRANTY.

3.5 Connecting IPOE-175S to PSE

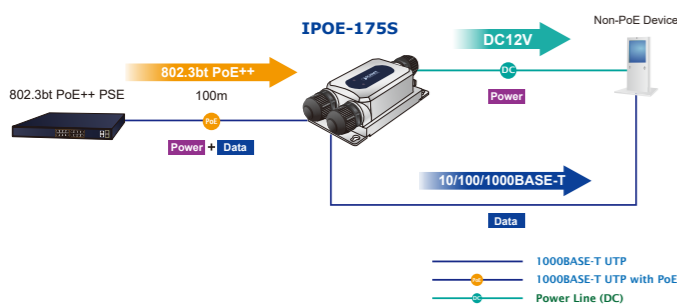

Step 1: Connect attached "Power cable with 2-pin terminal block" to the "DC Out" port of IPOE-175S Splitter.

Step 2: Connect the other end of DC power wires to remote device. Tighten the wire-clamp screws for preventing the wires from loosening.

Step 3: Connect the Cat5e/6 cable to "PoE In" port from an 802.3bt PoE++ switch/injector to the IPOE-175S Splitter.

Step 4: Connect the Cat5e/6 cable from "Data" port of the IPOE-175S to remote device.

Step 5: Power on the 802.3bt PoE++ switch/injector.

Step 6: Once the "DC Ready" LED indicator is steadily lit steadily, it shows it is providing 12V DC power.

- 10 -

| | |
|------------------------|---|
| Dimensions (W x D x H) | 150 x 43.8 x 72.94 mm 169.85 x 43.8 x 72.94 mm, with cable gland |
| Weight | 424g |
| MTBF | >100,000 hours |
| Network Cable | 10BASE-T: UTP category 3, 5 cable (≤100m) 100BASE-TX: UTP category 5, 5e cable (≤100m) 1000BASE-T: UTP category 5e, 6 cable (≤100m) |
| Power over Ethernet | |
| PoE Standard | IEEE 802.3bt PoE++ type 3 PD Backward compatible with IEEE 802.3at PoE+ |
| PoE Power Supply Type | 802.3bt PoE++/PoH (Power over HDBaseT) 802.3at PoE+ End-span/Mid-span |
| PoE Power Output | DC 12V, 5A (60W, full load) |
| Power Pin Assignment | 1/2 (-); 3/6 (+), 4/5 (+), 7/8 (-) or 1/2 (+); 3/6 (-), 4/5 (+), 7/8 (-) |
| Standards Conformance | |
| Regulatory Compliance | FCC Part 15 Class A, CE |
| Stability Testing | IEC 60068-2-32 (Free fall) IEC 60068-2-27 (Shock) IEC 60068-2-6 (Vibration) |

- 12 -

| | |
|------------------------|---|
| Standards Conformances | IEEE 802.3 10BASE-T Ethernet IEEE 802.3u 100BASE-TX Fast Ethernet IEEE 802.3ab 1000BASE-T Gigabit Ethernet IEEE 802.3af Power over Ethernet IEEE 802.3at Power over Ethernet Plus IEEE 802.3bt Power over Ethernet Plus Plus |
| Environment | |
| Operating Temperature | -40 ~ 75 degrees C |
| Storage Temperature | -40 ~ 85 degrees C |
| Humidity | 5 ~ 95% (non-condensing) |



The PoE power output ability will depend on the distance.

- 13 -

5. Customer Support

Thank you for purchasing PLANET products. You can browse our online FAQ resource and user's manual on PLANET web site first to check if it could solve your issue. If you need more support information, please contact PLANET support team.

PLANET online FAQs:
<https://www.planet.com.tw/en/support/faq>

Support team mail address:
support@planet.com.tw

Copyright © PLANET Technology Corp. 2020.
Contents are subject to revision without prior notice.
PLANET is a registered trademark of PLANET Technology Corp.
All other trademarks belong to their respective owners.

- 14 -