

User's Manual



RS232/RS422/RS485

Modbus Gateway Series

▶ **MG-110 / MG-115AT / MG-120**



Trademarks

Copyright © PLANET Technology Corp. 2020.

Contents are subject to revision without prior notice.

PLANET is a registered trademark of PLANET Technology Corp. All other trademarks belong to their respective owners.

Disclaimer

PLANET Technology does not warrant that the hardware will work properly in all environments and applications, and makes no warranty and representation, either implied or expressed, with respect to the quality, performance, merchantability, or fitness for a particular purpose. PLANET has made every effort to ensure that this User's Manual is accurate; PLANET disclaims liability for any inaccuracies or omissions that may have occurred.

Information in this User's Manual is subject to change without notice and does not represent a commitment on the part of PLANET. PLANET assumes no responsibility for any inaccuracies that may be contained in this User's Manual. PLANET makes no commitment to update or keep current the information in this User's Manual, and reserves the right to make improvements to this User's Manual and/or to the products described in this User's Manual, at any time without notice.

If you find information in this manual that is incorrect, misleading, or incomplete, we would appreciate your comments and suggestions.

FCC Warning

This equipment has been tested and found to comply with the limits for a Class A digital device, pursuant to Part 15 of the FCC Rules. These limits are designed to provide reasonable protection against harmful interference when the equipment is operated in a commercial environment. This equipment generates, uses, and can radiate radio frequency energy and, if not installed and used in accordance with the Instruction manual, may cause harmful interference to radio communications. Operation of this equipment in a residential area is likely to cause harmful interference in which case the user will be required to correct the interference at his own expense.

CE Mark Warning

This is a Class A product. In a domestic environment, this product may cause radio interference, in which case the user may be required to take adequate measures.

Energy Saving Note of the Device

This power required device does not support Standby mode operation. For energy saving, please remove the power cable to disconnect the device from the power circuit. In view of saving the energy and reducing the unnecessary power consumption, it is strongly suggested to remove the power connection for the device if this device is not intended to be active.

WEEE Warning



To avoid the potential effects on the environment and human health as a result of the presence of hazardous substances in electrical and electronic equipment, end users of electrical and electronic equipment should understand the meaning of the crossed-out wheeled bin symbol. Do not dispose of WEEE as unsorted municipal waste and have to collect such WEEE separately.

Revision

PLANET MG-11x Series User's Manual

Model:MG-110 / MG-115A / MG-120

Revision: 1.0 (August, 2020)

Part No: EM-MG-11x_v1.0

TABLE OF CONTENTS

1. INTRODUCTION	5
1.1 Packet Contents	5
1.2 Product Description	6
1.3 How to Use This Manual	10
1.4 Product Features	11
1.5 Product Specifications	12
2. INSTALLATION	15
2.1 Hardware Description	15
2.1.1 Physical Dimensions	15
2.1.3 Front / Top Panel	19
2.1.4 LED Indications	20
2.1.5 Rear Panel	20
2.1.6 Power Information:	21
2.1.7 Serial Port Pin Define	22
2.2 Installing the Modbus Gateway	23
2.2.1 Installation Steps	23
2.2.2 Wall-mount Installation	24
2.2.3 Media Chassis Installation (MG-110/115A)	25
2.2.4 Optional DIN-rail Installation.....	25
3. MODBUS GATEWAY MANAGEMENT	27
3.1 Requirements	27
3.2 Web Management	28
3.2.1 Logging in to the Modbus Gateway.....	28
3.3 Remote Management.....	30
3.4 PLANET Smart Discovery Utility	31
3.5 Getting Started with MB VCOM Utility.....	33
3.5.1 Installation of MB VCOM Utility	33
3.5.2 Searching Modbus Gateway	33
4. WEB CONFIGURATION	35
4.1 Main Web Page	37
4.2 System.....	38

4.2.1 System.....	38
4.2.2 Port.....	40
4.2.3 Device.....	41
4.2.4 Time.....	41
4.2.5 Console.....	42
4.2.6 Email.....	42
4.3 Accessible IP.....	44
4.4 Network.....	45
4.5 Modbus Gateway.....	46
4.5.1 Serial setup.....	46
4.5.2 Operation mode.....	47
4.5.2.1 Disable mode.....	47
4.5.2.2 RTU Slave mode.....	48
4.5.2.3 RTU Master mode.....	49
4.5.2.4 ASCII Slave mode.....	49
4.5.2.5 ASCII Master mode.....	50
4.5.3 MB COM.....	50
4.5.4 Modbus Config.....	51
4.5.4.1 Router.....	51
4.5.4.2 Mapping.....	52
4.5.4.3 Parameters.....	54
4.5.5 Priority Control.....	54
4.5.5.1 Master.....	54
4.5.5.2 TCP.....	55
4.5.5.3 Request.....	55
4.6 SNMP Setup.....	56
4.7 Maintenance.....	57
4.7.1 Change Password.....	57
4.7.2 Load Default.....	57
4.7.3 Firmware Update.....	58
4.8 Save and Restart.....	59
5. SOFTWARE MB VCOM UTILITY.....	60
5.1 Installing the VCOM Utility.....	60
5.2 Search Devices.....	63
5.3 COM Port Mapping.....	64

1. INTRODUCTION



Thank you for purchasing PLANET MG-110/MG-115A/ MG-120 Modbus Gateway. "Modbus Gateway" is used as an alternative name in this User's Manual.

MG-110	1-Port RS232/422/485 Modbus Gateway
MG-115A	1-Port RS232/422/485 Modbus Gateway with 1-Port 100BASE-FX SFP
MG-120	2-Port RS232/422/485 Modbus Gateway

"Modbus Gateway" mentioned in this Guide refers to the MG-110/MG-115A/ MG-120.

1.1 Packet Contents

Open the box of the Modbus Gateway and carefully unpack it. The box should contain the following items:

The Modbus Gateway x 1	User's Manual x 1
	
External AC-DC Power Adapter x 1	
	

If any of these are missing or damaged, please contact your dealer immediately; if possible, retain the carton including the original packing material, and use them again to repack the product in case there is a need to return it to us for repair.

1.2 Product Description

Standard Modbus TCP/RTU/ASCII Network Integration

PLANET **MG-11x** 1-port RS232/422/485 Modbus Gateway Series supports the standard Modbus Protocol, which makes it possible for converting any Modbus Protocols between Modbus TCP, Modbus RTU, and Modbus ASCII for all supported hardware interfaces. Its serial protocol can be used for industrial automation where SCADA or HMI system is in place. Moreover, its network integration can be upgraded from the SNMP network to the automated Modbus TCP network, which brings interconnection over Ethernet longer distances, thus making a network infrastructure more flexible.

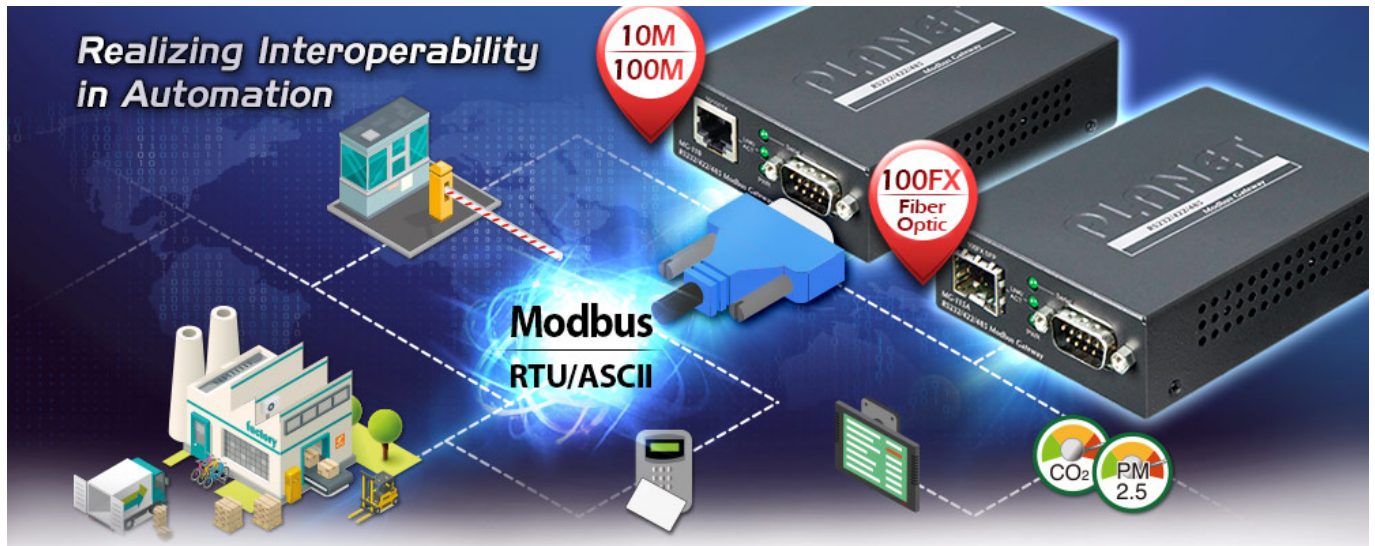

A Conversion Bridge for Flexible Network Deployment

The MG-11x Series can be a conversion bridge between the equipment with the Modbus RTU/ASCII Protocol and the administrator workstations that run the Modbus TCP/IP Protocol. The RS232/422/485 serial interface of the MG-11x Series provides the Modbus RTU/ASCII operation mode and various baud rate options to meet the demand of integration between the Modbus TCP/IP Protocol, Modbus RTU Master/Slave Protocol and Modbus ASCII Master/Slave Protocol.

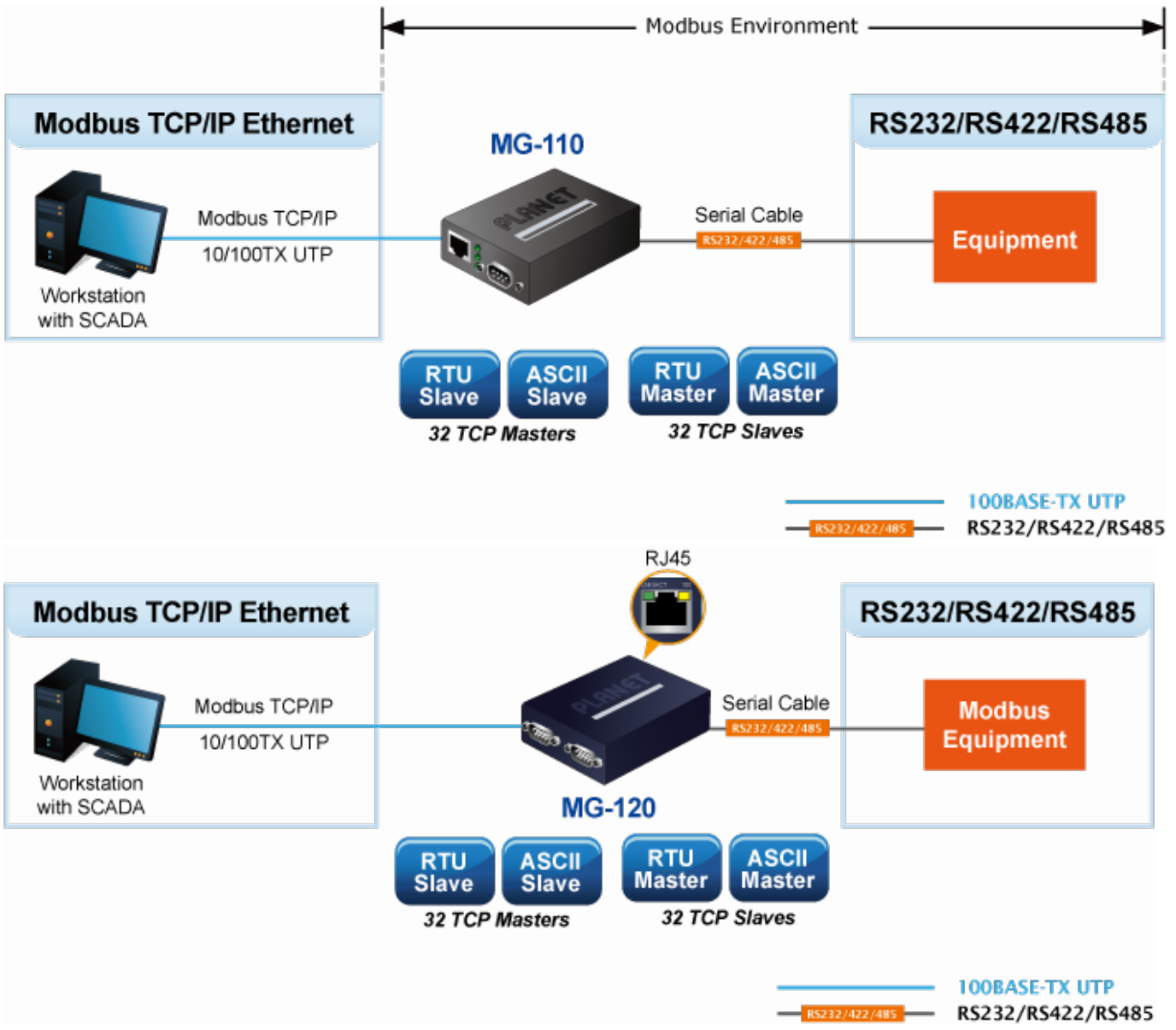

The advantage of having the MG-11x Series is to assist users to build an environment between the Modbus TCP Protocol and the Modbus RTU/ASCII Protocol easily, thus offering an application solution to the control equipment without Ethernet ports, and the control equipment can only control through a PC workstation or control panel.

In addition, the effective integration solution of Modbus Ethernet devices, Modbus serial equipment or multi Modbus master / slave in an hybrid network brings the following:

- Master mode supports up to 32 TCP slave connection requests
- Slave mode supports up to 32 TCP master connection requests

Differences between Serial Devices and Modbus Gateway

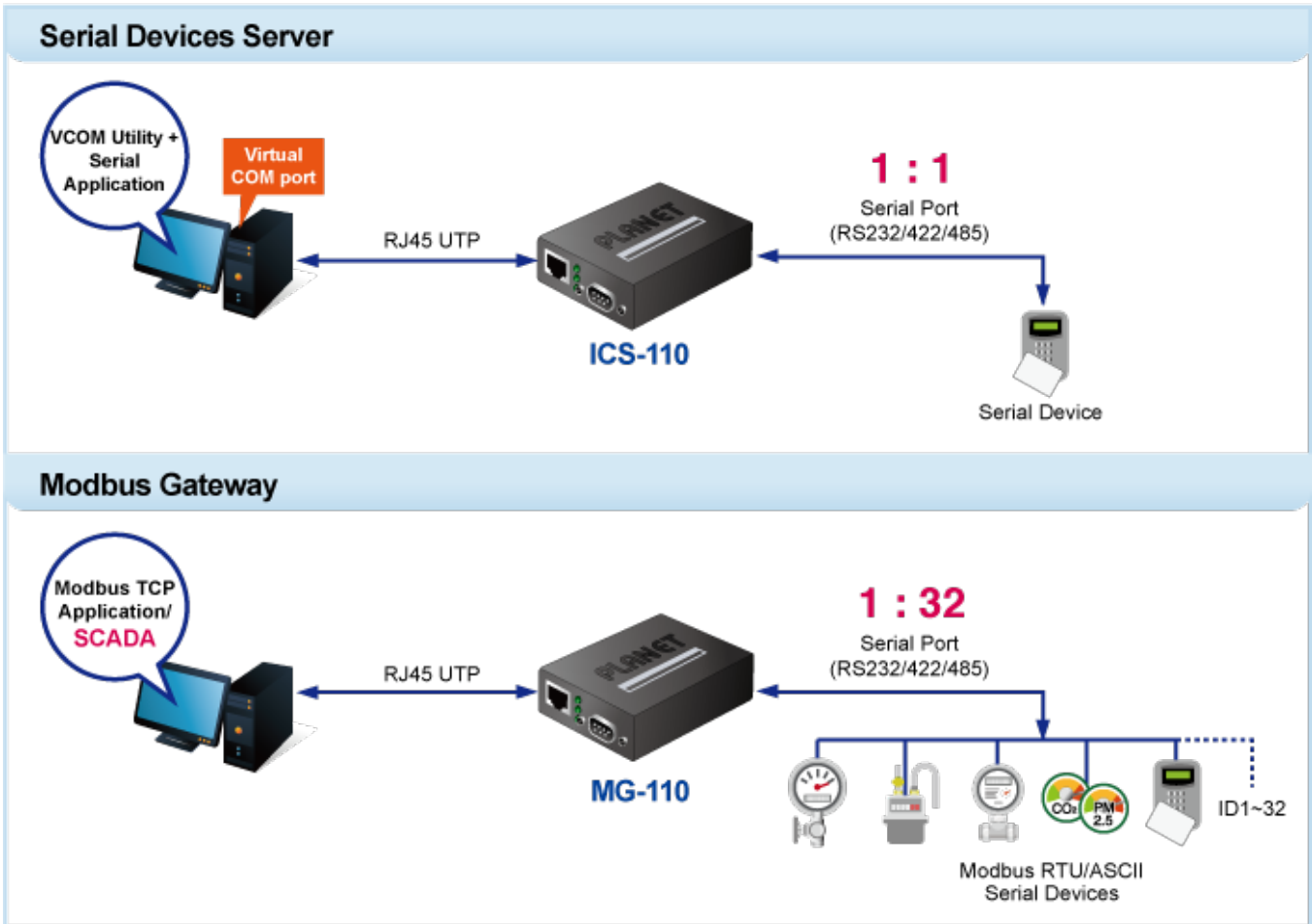

Remote Management

The MG-11x Series makes the connected Modbus RTU/ASCII equipment become IP-based facilities and is able to connect to the Modbus TCP/IP network via its RS232/422/485 serial interface and **10/100BASE-TX RJ45** or **100BASE-FX** Ethernet port. It provides a remote web management and telnet interface for efficient remote network management. The MG-11x Series also provides PLANET Modbus Gateway utility tool and supports PLANET Smart Discovery utility to help network administrator to easily get the current IP subnet address information or change the IP subnet address setting of the MG-11x Series.

Remote Management

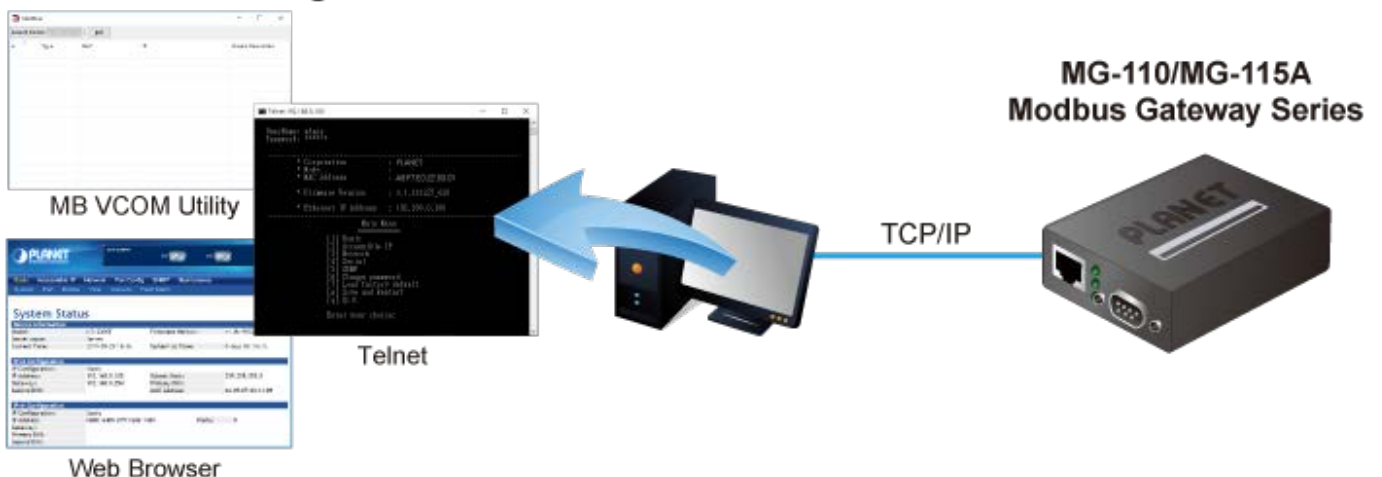

Modbus Serial Port State Monitoring

The MG-11x Series shows the details of the total bytes transmitted and received on the RS232/422/485 serial interface, and the detailed total number of frames transmitted and received on the remote web/telnet management interface. This function allows network administrator to check the status and statistics of the MG-11x Series via the single RS232/422/485 serial interface.

Fiber-optic Link Capability Extends the Range of Network Deployment (Only MG-115A)

The maximum distance between two IP devices via Ethernet UTP cable is 100 meters. To flexibly extend the deployment range of Modbus gateway, the MG-115A's SFP slot supporting 100BASE-FX SFP modules and more can reach a transmission distance of up to 120km.

Easy Chassis Installation (Only MG-110/115A)

The MG-11x Series can be used as a stand-alone unit or as a slide-in module to the PLANET Media Converter Chassis (MC-700 and MC-1500 chassis series). The media chassis can assist in providing DC power to the MG-11x Series and can be DIN-rail or wall mounted for efficient use of cabinet space, without the need of replacing the existing serial equipment and software system.

Optional installation method



Media Chassis Installation



DIN-rail Installation



Wall-mount Installation

1.3 How to Use This Manual

This User's Manual is structured as follows:

Section 2, INSTALLATION

It explains the functions of the MG-11x Series and how to physically install the MG-11x Series.

Section 3, MODBUS GATEWAY MANAGEMENT

The chapter explains how to manage the MG-11x Series in different ways.

Section 4, WEB CONFIGURATION

It describes how to configure by web interface.

Section 5, SOFTWARE VCOM UTILITY

It describes how to use software VCOM in the Virtual COM mode.

1.4 Product Features

▶ **Serial Interface**

- One/Two DB9 interface supports RS232, 2-wire RS485, 4-wire RS485 and RS422 standards
- Asynchronous serial data rates up to 921600bps

▶ **Ethernet Interface**

- 1-port 10/100BASE-TX RJ45 interface with auto MDI/MDI-X function
- 1-port 100BASE-FX SFP slot (MG-115A)

▶ **Management Function**

- Built-in IP-based **Web interface** and **telnet interface** for remote management
- Software Protocol supports Modbus TCP, Modbus RTU, Modbus ASCII, IP, ARP, DHCP and DNS
- Supports RTU Master, RTU Slave, ASCII Master, and ASCII Slave four serial operation modes via management interface
- Master mode supports 32 TCP slave connection requests
- Slave mode supports 32 TCP master connection requests
- PLANET Modbus Gateway utility for finding client device on the network.
- PLANET Smart Discovery utility automatically finds the client devices on the network
- Firmware upgrade/configuration backup and restore via HTTP protocol

▶ **Case and Installation**

- Compact size for easy Installation:
 - Standalone - Wall mountable or DIN-rail mounting (optional accessory)
 - Co-works with PLANET media chassis **MC-700/1500**. (Only MG-110/115A)
- -10 to 60 degrees C operating temperature
- Reset button for resetting to factory default

1.5 Product Specifications

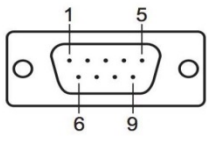
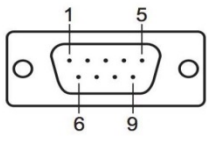
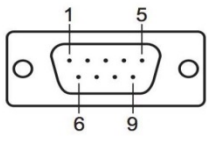
Product	MG-110	MG-115A	MG-120																																										
Serial Interface																																													
Serial Port	1 x DB9 male		2 x DB9 male																																										
Serial Standards	RS232/RS422/4-wire RS485/2-wire RS485																																												
Baud Rate (Data Rate)	50bps to 921Kbps																																												
Data Bits	5, 6, 7, 8																																												
Stop Bit	1, 1.5, 2																																												
Parity Type	Odd, Even, None, Space, Mark																																												
Flow Control	RTS/CTS and DTR/DSR (RS232 only) XON/XOFF																																												
Signals	RS232: TxD, RxD, RTS, CTS, DTR, DSR, DCD, GND RS422: Tx+, Tx-, Rx+, Rx-, GND 4-wire RS485: Tx+, Tx-, Rx+, Rx-, GND 2-wire RS485: Data A (+), Data B (-), GND																																												
Pin Assignment	<table border="1"> <thead> <tr> <th>Male DB9</th> <th>Pin</th> <th>RS232</th> <th>RS422 RS485-4W</th> <th>RS485-2W</th> </tr> </thead> <tbody> <tr> <td rowspan="9">  </td> <td>1</td> <td>DCD</td> <td>TxD+</td> <td>--</td> </tr> <tr> <td>2</td> <td>RxD</td> <td>TxD-</td> <td>--</td> </tr> <tr> <td>3</td> <td>TxD</td> <td>RxD-</td> <td>Data-</td> </tr> <tr> <td>4</td> <td>DTR</td> <td>RxD+</td> <td>Data+</td> </tr> <tr> <td>5</td> <td>GND</td> <td>GND</td> <td>GND</td> </tr> <tr> <td>6</td> <td>DSR</td> <td>--</td> <td>--</td> </tr> <tr> <td>7</td> <td>RTS</td> <td>--</td> <td>--</td> </tr> <tr> <td>8</td> <td>CTS</td> <td>--</td> <td>--</td> </tr> <tr> <td>9</td> <td>--</td> <td>--</td> <td>--</td> </tr> </tbody> </table>			Male DB9	Pin	RS232	RS422 RS485-4W	RS485-2W		1	DCD	TxD+	--	2	RxD	TxD-	--	3	TxD	RxD-	Data-	4	DTR	RxD+	Data+	5	GND	GND	GND	6	DSR	--	--	7	RTS	--	--	8	CTS	--	--	9	--	--	--
Male DB9	Pin	RS232	RS422 RS485-4W	RS485-2W																																									
	1	DCD	TxD+	--																																									
	2	RxD	TxD-	--																																									
	3	TxD	RxD-	Data-																																									
	4	DTR	RxD+	Data+																																									
	5	GND	GND	GND																																									
	6	DSR	--	--																																									
	7	RTS	--	--																																									
	8	CTS	--	--																																									
	9	--	--	--																																									
Operation Mode	RTU Master/RTU Slave/ASCII Master/ASCII Slave Master mode: Supports up to 32 TCP slave connection requests Slave mode: Supports up to 32 TCP master connection requests																																												
Ethernet Interface																																													
Ethernet Ports	1 x RJ45	1 x SFP	1 x RJ45																																										
Standard	10/100BASE-TX	100BASE-FX	10/100BASE-TX																																										
Distance	100m	2km to 120km, vary on SFP modules	100m																																										
ESD Protection	6KV																																												
Hardware																																													
Installation	DIN-rail kit and wall-mount ear																																												
Dimensions (W x D x H)	97 x 70 x 26mm	97 x 70 x 26mm	97 x 70 x 26mm																																										
Weight	184 g	185 g	189g																																										
LED Indicators	System: Link TP/SFP Port: Link/ Active Serial Port: Active																																												
Power Requirements	External Power Adaptor 5V DC, 2A max.																																												
Power Consumption	5.5 watts (max)																																												

Mechanical	Metal	
Reset Button	< 5 sec: System reboot > 5 sec: Factory default	
Management		
Management Interfaces	Web management Telnet Console management Windows-based VCOM Utility management SNMPv1, v2c / SNMP Trap UNI-NMS monitoring PLANET Smart Discovery Utility	
IP Version	IPv4	
Operation Mode	RTU Master RTU Slave ASCII Master ASCII Slave	
Virtual COM Utility Platform Supports	Windows-based Only: Windows XP Windows Server 2003 Windows 7 Windows Server 2008 Windows 8 (Must install the latest version of WinPcap) Windows Server 2012 (Must install the latest version of WinPcap) Windows 10	
Fault Alarm	Record: System log / SNMP trap	
Time	NTP	
Security	Accessible IP (white list)	
SNMP	SNMP v1 and v2c	
Standards Conformances		
Regulatory Compliance	FCC Part 15 Class A, CE Certification Class A	
Standards	IEEE 802.3 10BASE-T, IEEE 802.3u 100BASE-TX/100BASE-FX RFC 768 UDP RFC 793 TFTP RFC 791 IP RFC 792 ICMP RFC 854 Telnet RFC 958 NTP RFC 1908 SNMPv2c RFC 2068 HTTP RFC 2131 DHCP Client EIA/TIA RS232/422/485	
Regulatory Approval	RoHS	
Compatible Media Converter Chassis	MC-700, MC-1500, MC-1500R	N/A

Note.	Reset Button on the rear panel for resetting to factory default
Environment	
Operating Temperature	-10 ~ 60 degrees C
Storage Temperature	-10 ~ 70 degrees C
Humidity	5 ~ 95% (non-condensing)

2. INSTALLATION

This section describes the hardware features and installation of the Modbus Gateway' components on the desktop or rack. For easier management and control of the Modbus Gateway, familiarize yourself with its display indicators, and ports. Front panel illustrations in this chapter display the LED indicators. Before connecting any network device to the Modbus Gateway, please read this chapter completely.

2.1 Hardware Description

2.1.1 Physical Dimensions

- MG-110: 94 x 70 x 26mm (W x D x H)

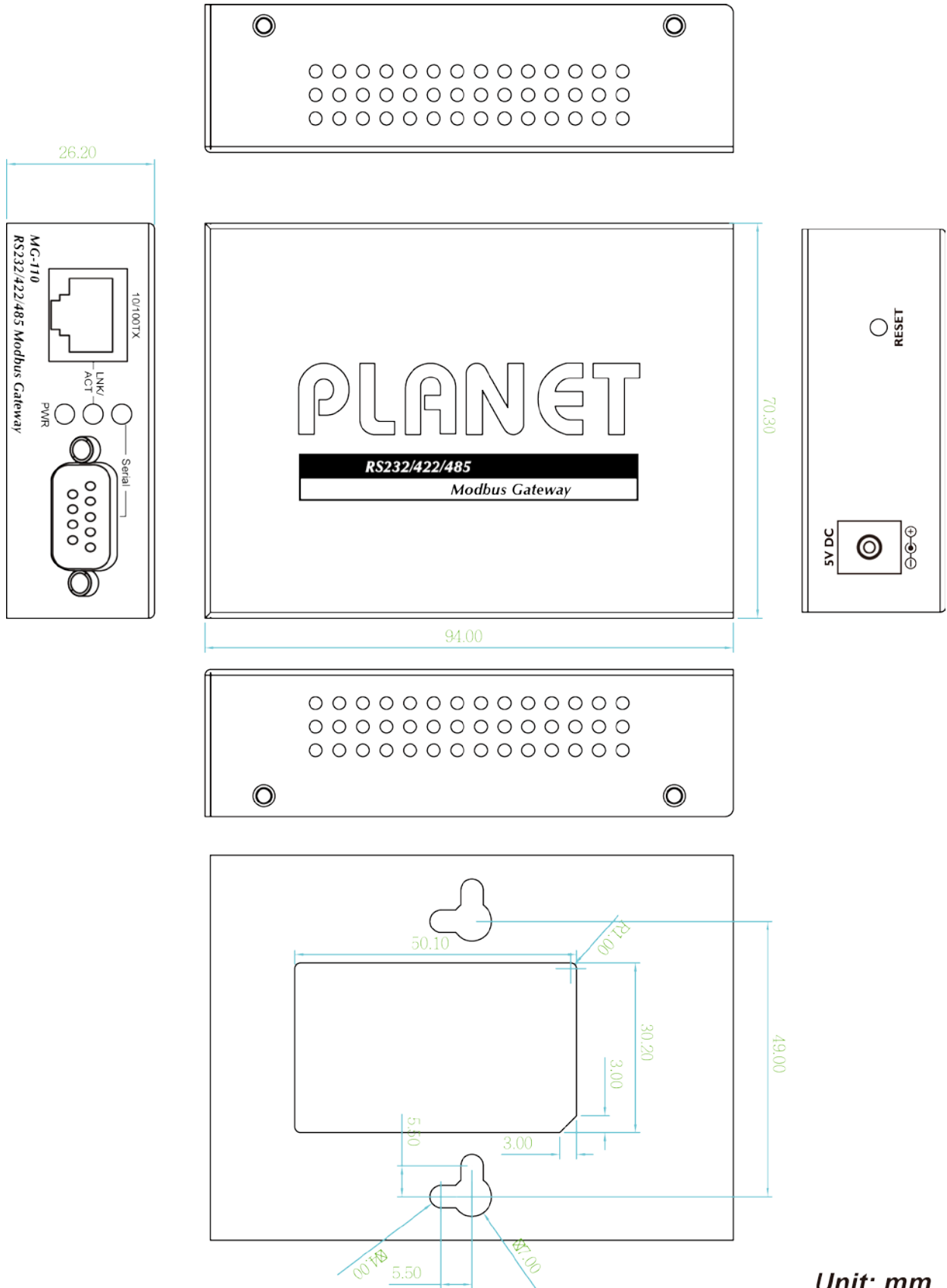

Unit: mm

- MG-115A: 94 x 70 x 26mm (W x D x H)

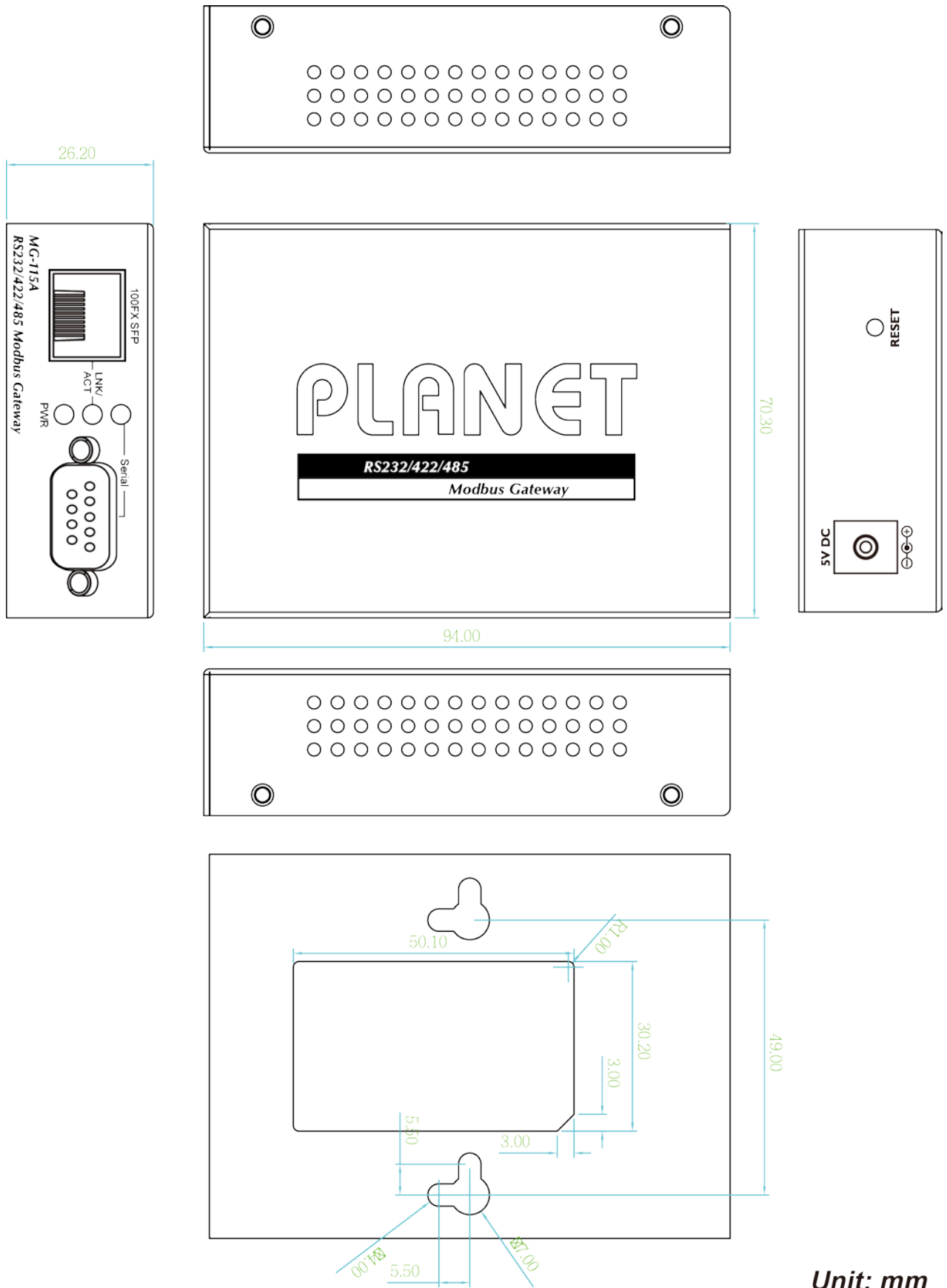

Unit: mm

- MG-120: 94 x 70 x 26mm (W x D x H)

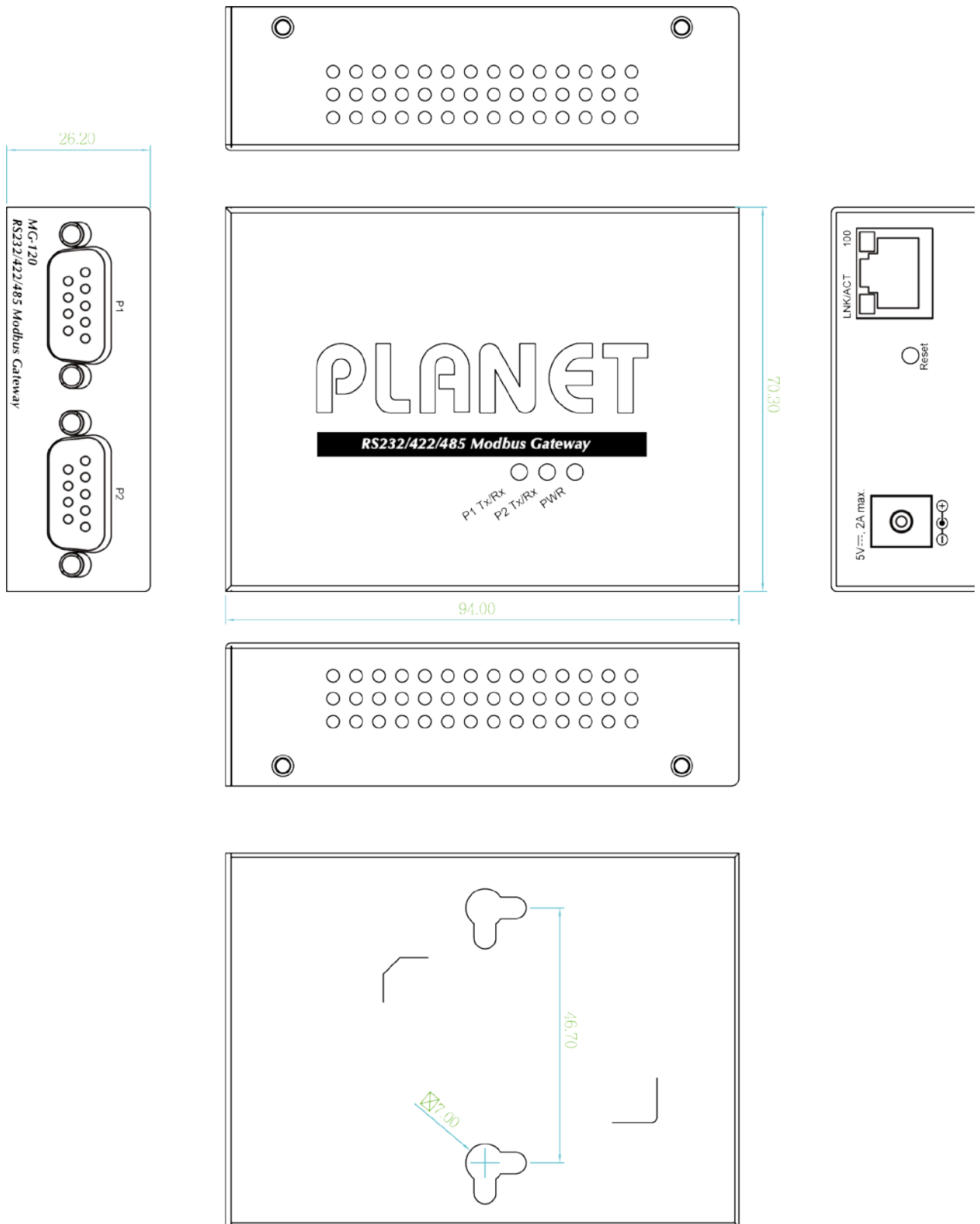

Unit: mm

2.1.3 Front / Top Panel

The front panels of the Modbus Gateways are shown in Figure 2-1-1.

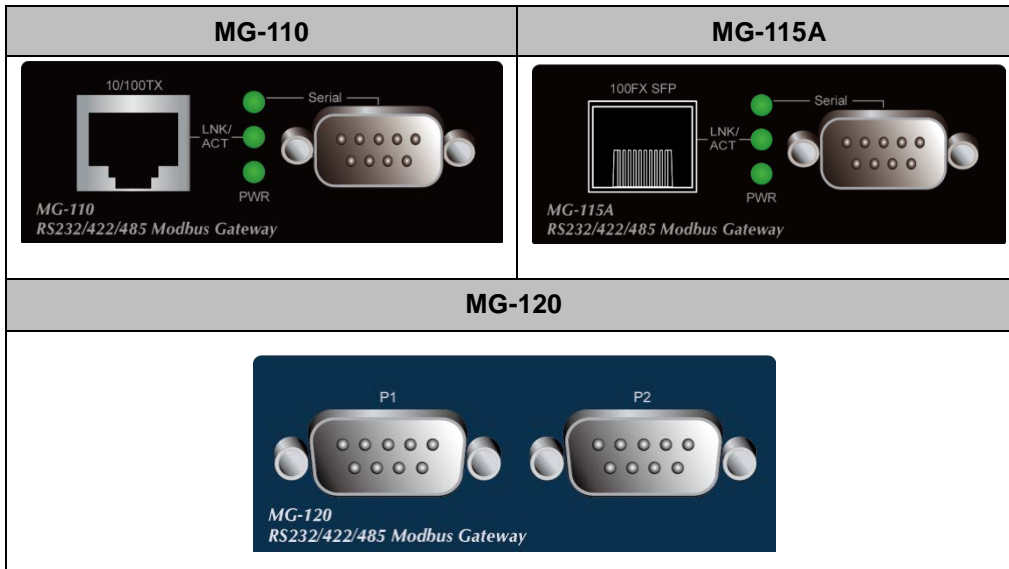

Figure 2-1-1: Front Panels of Modbus Gateway

The top panel of the MG-120 is shown in Figure 2-1-2.

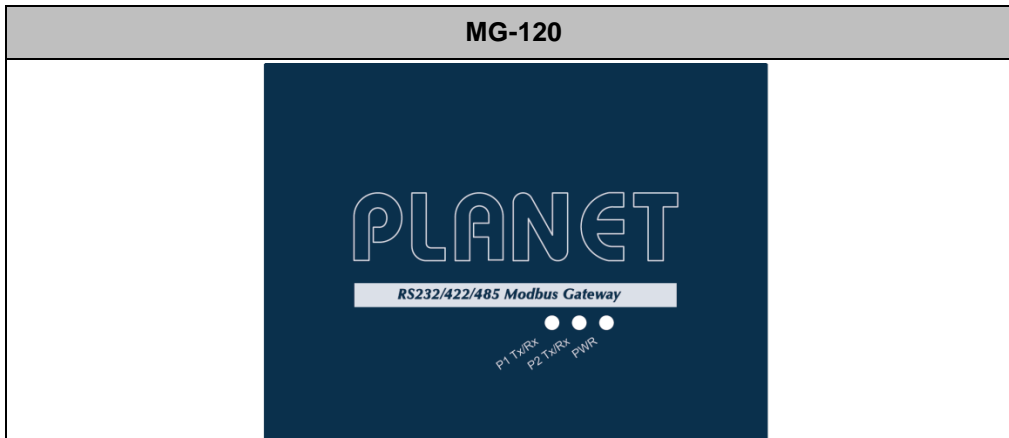

Figure 2-1-2: Top Panel of MG-120

- **Fast TP/ SFP interface**

10/100BASE-TX copper, RJ45 twisted-pair: Up to 100 meters.

100BASE-FX SFP interface, Up to 2km~120km, vary on SFP modules.

- **Serial Interface**

Supports RS-232, RS-422, RS-485 2-wire and RS485 4-wire.

2.1.4 LED Indications

The front/top panel LEDs indicate the instant status of power and system status, port links and data activity; they help monitor and troubleshoot when needed.

■ **System**

LED	Color	Function	
PWR	Green	Lights	Power is activated.
Serial (TX/RX)	Green	Blinks	To indicate the Serial Port is receiving or sending data

■ **10/100BASE-TX/100BASE-FX Port**

MG-110/115A

TP or Fiber	Green	Lights	To indicate that the Fast Ethernet port is successfully connecting to the network at 10Mbps or 100Mbps (Fiber port only 100Mbps)
		Blinks	To indicate the Fast Ethernet Port is receiving or sending data

MG-120

TP Port		Off	To indicate that the Fast Ethernet port is successfully connecting to the network at 10Mbps.
	Amber (100)	Lights	To indicate that the Fast Ethernet port is successfully connecting to the network at 100Mbps.
	Green (LNK/ACT)	Blinks	To indicate the TP Port is receiving or sending data

2.1.5 Rear Panel

The rear panels of Modbus Gateways consist of one DC jack, which accepts input power with 5V DC, 2A (Figure 2-1-3).

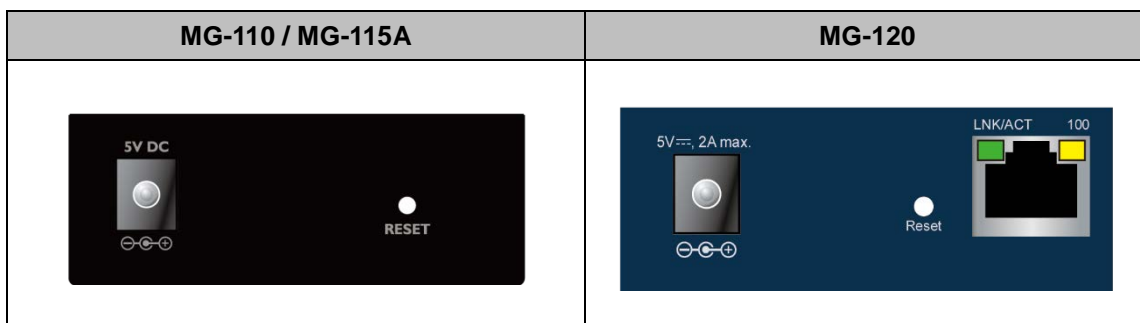

Figure 2-1-3: One DC jack for DC power input

■ **Reset button**

On the rear panel, the **reset button** is designed for rebooting the system. The following is the summary table of the reset button functions:

Reset Button	Reset Button Pressed and Released	Function
System Reset	< 5 sec: System reboot	Reboot the Modbus Gateway
	> 5 sec: Factory default	Reset the Modbus Gateway to Factory Default configuration. The Modbus Gateway will then reboot and load the default settings as shown below: <ul style="list-style-type: none"> ◦ Default Username: admin ◦ Default Password: admin ◦ Default IP address: 192.168.0.100 ◦ Subnet mask: 255.255.255.0 ◦ Default Gateway: 192.168.0.254

2.1.6 Power Information:

The central pole of the Modbus Gateway's power jacks measures 2.5mm wide that require +5VDC power input. It conforms to the bundled AC-DC adapter and PLANET's media chassis. Should you have the issue of power connection, please contact your local sales representative.

Please keep the AC-DC adapter as a spare part when the Modbus Gateway is installed in a media chassis.(MG-110/115A)

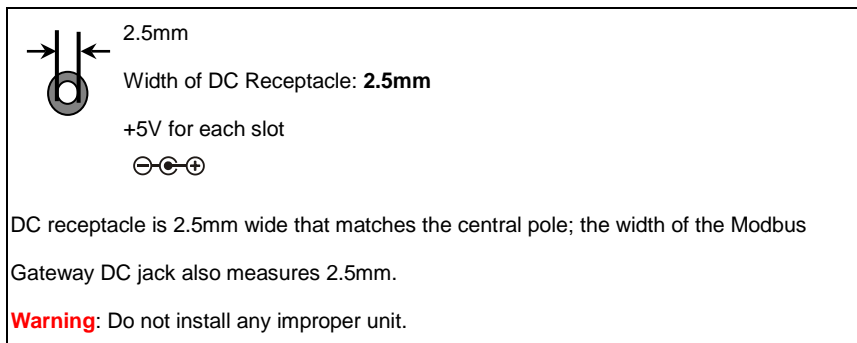

The device is a power-required device, meaning it will not work till it is powered. If your networks should be active all the time, please consider using UPS (Uninterrupted Power Supply) for your device. It will prevent you from network data loss or network downtime.

In some areas, installing a surge suppression device may also help to protect your Modbus Gateway from being damaged by unregulated surge or current to the converter or the power adapter.

2.1.7 Serial Port Pin Define

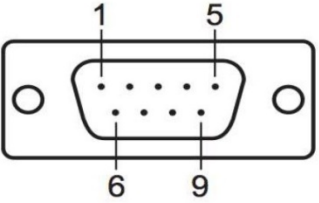
Male DB9	Pin	RS232	RS422 RS485-4W	RS485-2W
	1	DCD	TxD+	--
	2	RxD	TxD-	--
	3	TxD	RxD-	Data-
	4	DTR	RxD+	Data+
	5	GND	GND	GND
	6	DSR	--	--
	7	RTS	--	--
	8	CTS	--	--
	9	--	--	--

2.2 Installing the Modbus Gateway

This section describes how to install your Modbus Gateway and make connections to the Modbus Gateway. Please read the following section and perform the procedure in the order being presented. To install your Modbus Gateway on a desktop or rack, simply complete the following steps.

2.2.1 Installation Steps

1. **Unpack the Modbus Gateway**
2. **Check if the DIN-rail bracket is screwed on the Modbus Gateway or not.** If the DIN-rail bracket is not screwed on the **Modbus Gateway**, please refer to **DIN-rail Mounting** section for DIN-rail installation. If users want to wall-mount the **Modbus Gateway**, please refer to the **Wall Mount Plate Mounting** section for wall-mount plate installation.
3. **To hang the Modbus Gateway on the DIN-rail track or wall.**
4. **Power on the Modbus Gateway.** Connect the **5V DC** power adapter to the Modbus Gateway ,the power LED on the **Modbus Gateway** will light up. Please refer to the **LED Indicators** section for indication of LED lights.
5. **Prepare Network cables for Ethernet connection.**
 - Use standard network (UTP) cables with RJ45
 - Use Multi-mode or Single-mode fiber patch cord with LC connector and 100BASE-FX SFP transceiver (MG-115A only).
6. **Insert one side of RJ45 cable (category 5) or Fiber cable into the Modbus Gateway Ethernet port** (RJ45/SFP port) while the other side to the network device's Ethernet port (RJ45/SFP port), e.g., Switch PC or Server. The “**LNK/ACT**” LED on the **Modbus Gateway** will light up when the cable is connected with the network device. Please refer to the **LED Indicators** section for LED light indication.



Make sure that the connected network devices support MDI/MDI-X. If it does not support, use the crossover Category 5 cable.

7. **When all connections are set and all LED lights show normal, the installation is completed.**

2.2.2 Wall-mount Installation

Step 1: Please find the wall that can mount the Modbus Gateway

Step 2: Screw two screws on the wall.

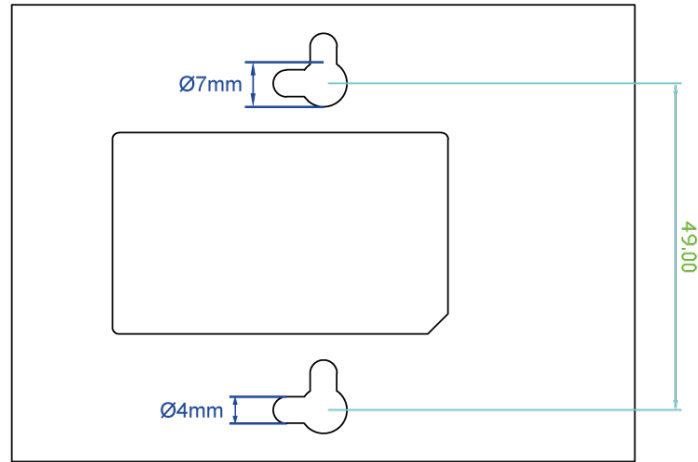

Step 3: Hang the Modbus Gateway on the screws from the wall.

Step 4: Refer to Chapter **2.1.5 Power Information** on power supply to the Modbus Gateway .

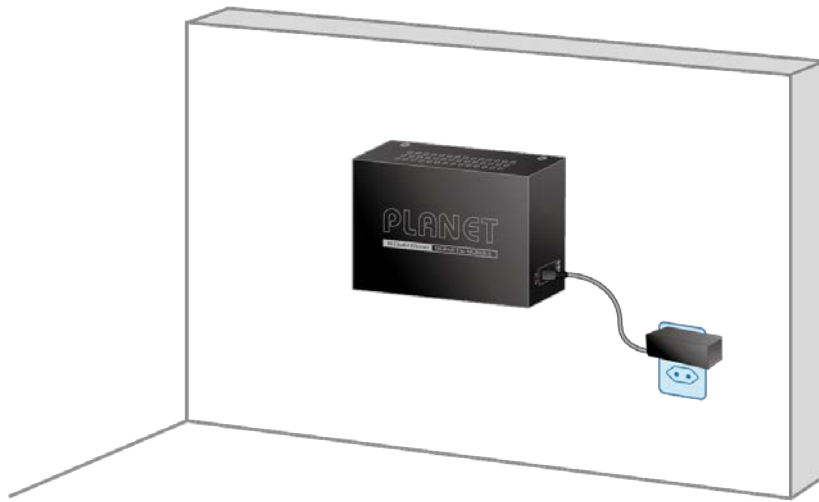

Before mounting the device to the wall, please check the location of the electrical outlet and the length of the Ethernet cable.

2.2.3 Media Chassis Installation (MG-110/115A)

To install the Modbus Gateway in a **10-inch** or **19-inch** standard rack, follow the instructions described below.

Step 1: Place your Modbus Gateway on a hard flat surface, with the front panel positioned towards your front side.

Step 2: Carefully slide in the module until it is fully and firmly fitted into the slot of the chassis; the Power LED of the Modbus Gateway will turn ON.

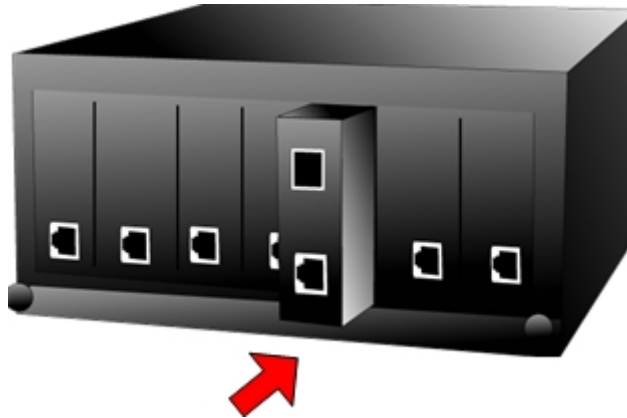

Figure 3-2: Insert Modbus Gateway into an available slot



1. Never push the Modbus Gateway into the slot with force; it could damage the chassis.
2. The Media Converter Chassis supports hot-swap; there is no need to turn off the whole chassis before sliding in the new converter.

Caution

2.2.4 Optional DIN-rail Installation

There are two DIN-rail holes on the left side of the Modbus Gateway that allows to be easily installed by DIN-rail mounting. PLANET optional DIN-rail mounting kit – RKE-DIN -- can be ordered separately. Refer to the following steps for the DIN-rail mounting of the Modbus Gateway:

Step 1: Screw the DIN rail on the Modbus Gateway

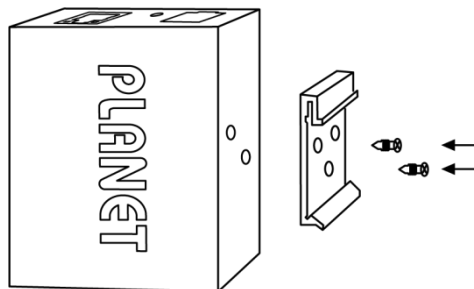

Step 2: Now slide the DIN rail into the track.

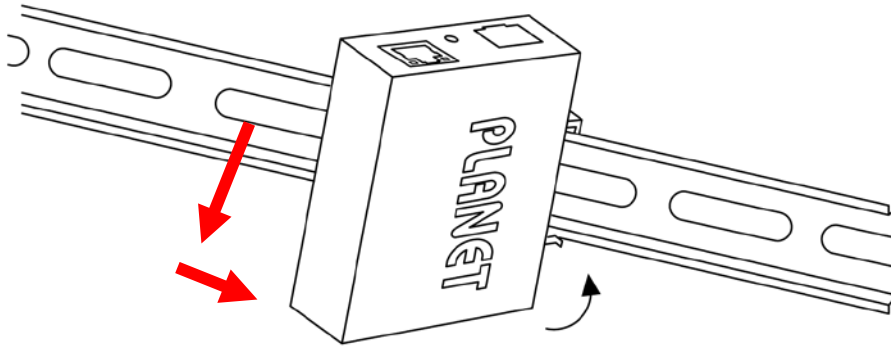

Step 3: Check whether the DIN rail is tightly on the track.

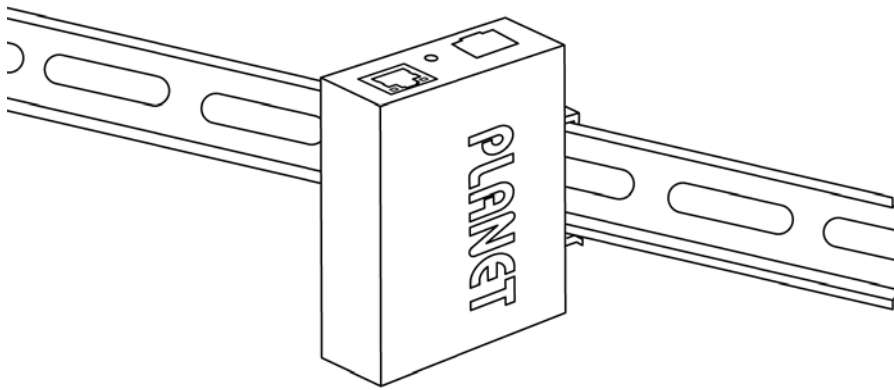

You must use the screws supplied with the mounting brackets. Damage caused to the parts by using incorrect screws would invalidate your warranty.

Caution

3. MODBUS GATEWAY MANAGEMENT

This chapter covers the following topics as to how to manage the Modbus Gateway:

- Requirements
- Web Management
- Remote Management
- PLANET Smart Discovery Utility
- MB VCOM Utility

3.1 Requirements

- **Workstations** running Windows 2000/XP, 2003, Vista/7/8/10, 2008, Mac OS 9 or later, or Linux, UNIX , or other platforms compatible with **TCP/IP** protocols.
- **Workstation** is installed with **Ethernet NIC** (Network Interface Card)
- **Network cables**
 - Use standard network (UTP) cables with RJ45
 - Use Multi-mode or Single-mode fiber patch cord with LC connector and 100BASE-FX SFP transceiver (MG-115A only).
- The above workstation is installed with **Web Browser** and **JAVA runtime environment** plug-in



It is recommended to use Internet Explorer 7.0 or above to access Modbus Gateway.

3.2 Web Management

The Modbus Gateway offers management features that allow users to manage the Modbus Gateway from anywhere on the network through a standard browser such as Microsoft Internet Explorer. After you set up your IP address for the switch, you can access the Modbus Gateway's Web interface applications directly in your Web browser by entering the IP address of the Modbus Gateway.

For example, the default IP address of the Modbus Gateway is 192.168.0.100, then the manager PC should be set to **192.168.0.x** (where x is a number between 1 and 254, except 100), and the default subnet mask is 255.255.255.0.

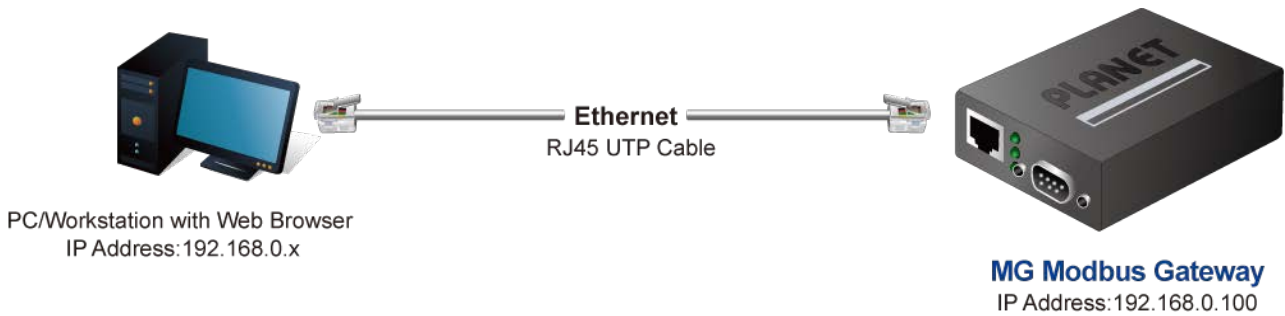

Figure 3-2-1: Web Management

You can then use your Web browser to list and manage the Modbus Gateway configuration parameters from one central location, just as if you were directly connected to the Modbus Gateway's console port. Web Management requires either **Microsoft Internet Explorer 7.0** or later, **Safari** or **Mozilla Firefox 1.5** or later.

3.2.1 Logging in to the Modbus Gateway

1. Use Internet Explorer 8.0 or above for Web browser and enter IP address http://192.168.0.100 (the factory default IP address) to access the Web interface.
2. When the following dialog box appears, please enter the default user name "admin" and password "admin" (or the password you have changed before) as shown in Figure 4-2.

Default IP Address: **192.168.0.100**
 Default User Name: **admin**
 Default Password: **admin**

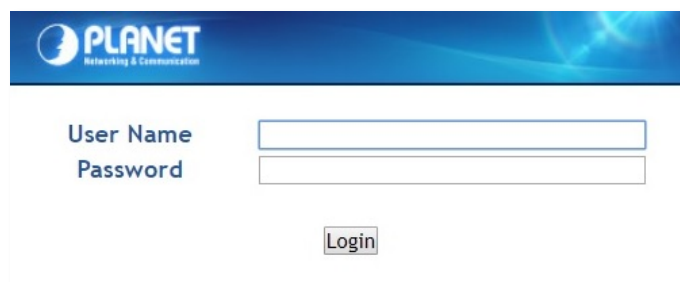

Figure 3-2-2: Login Screen

3. After entering the password, the main screen appears as shown in Figure 3-2-3.



Figure 3-2-3: Web Main Screen of Modbus Gateway

4. The Main Menu in the middle of the Web page lets you access all the functions and statuses. It appears as shown in Figure 3-2-4.



Figure 3-2-4: Main menu

Now, you can use the Web management interface to continue the Modbus Gateway management. Please refer to the user manual for more.



1. For security reason, **please change and memorize the new password after this first setup.**
2. Only accept command in lowercase letter under web interface.

3.3 Remote Management

The Modbus Gateway also supports Telnet for remote management. You can use Telnet to open a terminal session over one of the Ethernet ports. The Modbus Gateway asks for user name and password for remote login when using Telnet; please use the following default IP address, username and password for the first-time login.

Default IP Address: **192.168.0.100**

Default Username: **admin**

Default Password: **admin**

You will be presented with a text menu displaying the Modbus Gateway's general settings, which you will be able to view and modify. It appears as shown in Figure 3-3-1.

```
UserName: admin
Password: *****

-----
* Corporation      : PLANET
* Model           : MG-110
* MAC Address     : 66:09:07:03:14:89
* Firmware Version : v1.1910b200518
* Ethernet IP Address : 192.168.0.100
-----

          Main Menu
          =====
          [1] Basic
          [2] Accessible IP
          [3] Network
          [4] SNMP
          [5] Change password
          [6] Load factory default
          [s] Save and Restart
          [q] Quit

Enter your choice:
```

Figure 3-3-1: Remote management

3.4 PLANET Smart Discovery Utility

For easily listing the Modbus Gateway in your Ethernet environment, the Planet Smart Discovery Utility is an ideal solution. The following installation instructions are to guide you to running the Planet Smart Discovery Utility.

1. Download the Planet Smart Discovery Utility from the administrator PC.
2. Run this utility as the following screen appears.

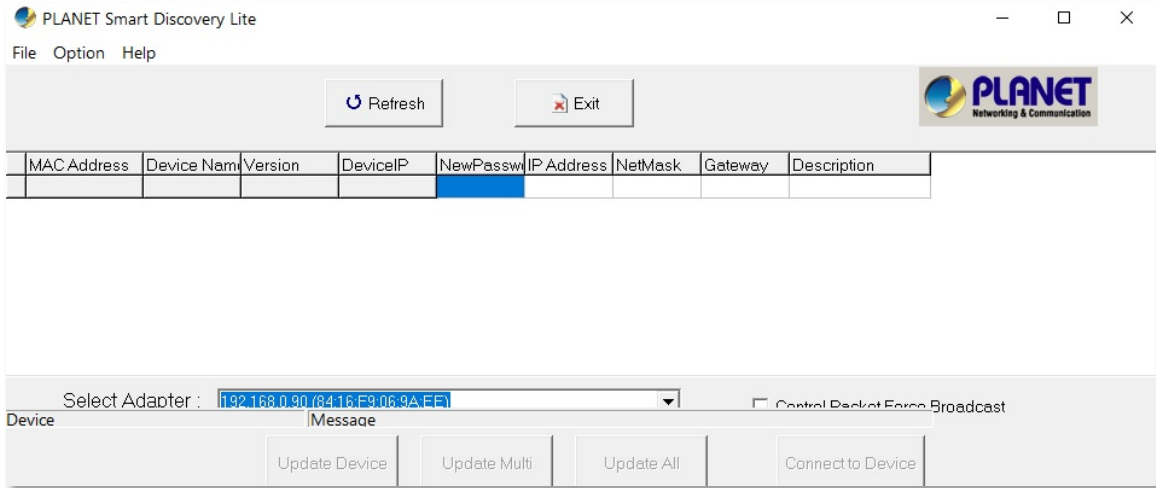

Figure 3-4-1: Planet Smart Discovery Utility Screen



If there are two LAN cards or above in the same administrator PC, choose a different LAN card by using the **“Select Adapter”** tool.

3. Press the **“Refresh”** button for the currently connected devices in the discovery list as shown in [Figure 3-4-2](#):

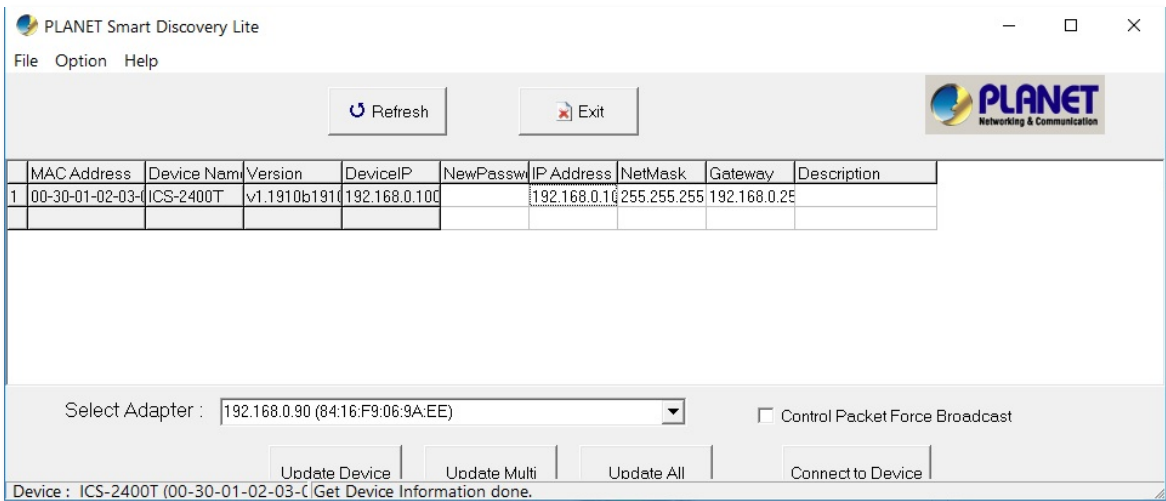

Figure 3-4-2: Planet Smart Discovery Utility Screen

1. This utility shows all the necessary information from the devices, such as MAC address, device name, firmware version, and device IP subnet address. It can also assign new password, IP subnet address and description to the devices.

2. After setup is completed, press the **“Update Device”**, **“Update Multi”** or **“Update All”** button to take effect. The functions of the 3 buttons above are shown below:

- **Update Device:** Use current setting on one single device.
- **Update Multi:** Use current setting on multi-devices.
- **Update All:** Use current setting on whole devices in the list.

The same functions mentioned above also can be found in **“Option”** tools bar.

3. To click the **“Control Packet Force Broadcast”** function, it allows you to assign a new setting value to the Web Smart Switch under a different IP subnet address.

4. Press the **“Connect to Device”** button and the Web login screen appears as shown in [Figure 3-4-2](#).

5. Press the **“Exit”** button to shut down the Planet Smart Discovery Utility.

3.5 Getting Started with MB VCOM Utility

With MB VCOM Utility, you can easily search one or multiple MG-110 or MG-115A Modbus Gateway over the network from a remote location.



3.5.1 Installation of MB VCOM Utility

The MG-110/MG-115A MB VCOM Utility can be downloaded from PLANET Web site. Please locate and run the setup program "mbgsetup.exe" and follow the on-screen instructions.



download link: <https://www.planet.com.tw/en/support/downloads?&method=keyword&keyword=MG&view=6#list>

After installing, rebooting your workstation/PC is required.



If you have difficulty in downloading or executing MB VCOM Utility, turn off the firewall and anti-virus software first.

3.5.2 Searching Modbus Gateway

First click "Add Device" and then click "Search" if Serial Server has access to network, as shown below.

4. WEB CONFIGURATION

This section introduces the configuration and functions of the Web-based management from Modbus Gateway.

About Web-based Management

The Modbus Gateway offers management features that allow users to manage the Modbus Gateway from anywhere on the network through a standard browser such as Microsoft Internet Explorer.

The Web-based Management supports Internet Explorer 7.0. It is based on Java Applets with an aim to reduce network bandwidth consumption, enhance access speed and present an easy viewing screen.



By default, IE7.0 or later version does not allow Java Applets to open sockets. The user has to explicitly modify the browser setting to enable Java Applets to use network ports.

The Modbus Gateway can be configured through an Ethernet connection, making sure the manager PC must be set to the same IP subnet address with the Modbus Gateway.

For example, the default IP address of the Modbus Gateway is **192.168.0.100**, then the manager PC should be set to **192.168.0.x** (where x is a number between 1 and 254, except 100), and the default subnet mask is 255.255.255.0.

If you have changed the default IP address of the Modbus Gateway to 192.168.1.1 with subnet mask 255.255.255.0 via console, then the manager PC should be set to 192.168.1.x (where x is a number between 2 and 254) to do the relative configuration on manager PC.

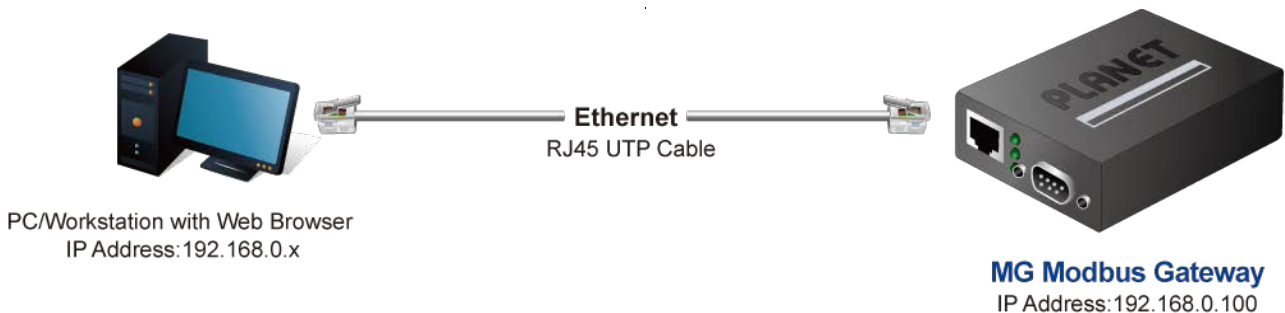

Figure 4-1-1: Web Management

■ Logging on to the Modbus Gateway

1. Use Internet Explorer 7.0 or above Web browser. Enter the factory default IP address to access the Web interface. The factory default IP address is shown as follows:

Default IP Address: **192.168.0.100**

Default Username: **admin**

Default Password: **admin**

- When the following login screen appears, please enter the default username "admin" with password "admin" (or the username/password you have changed via console) to log in the main screen of **Modbus Gateway**. The login screen in [Figure 4-1-2](#) appears.

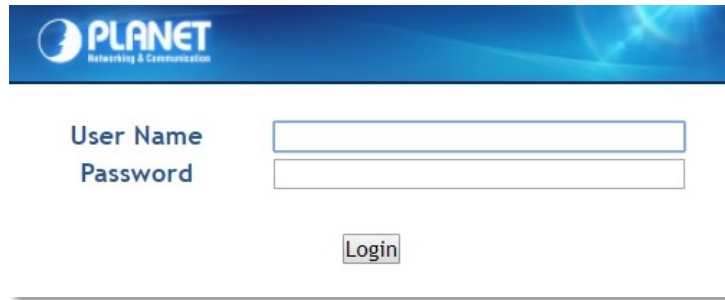

Figure 4-1-2: Login Screen

- After a successful login, the main screen appears as shown in [Figure 4-1-3](#) below.



Figure 4-1-3: Web Main Page

Now, you can use the Web management interface to continue the switch management or manage the Modbus Gateway by Web interface.

4.1 Main Web Page

The Modbus Gateway provides a Web-based browser interface for configuring and managing it. This interface allows you to access the Modbus Gateway using the Web browser of your choice. The main web page is shown in [Figure 4-1-4](#)





Figure 4-1-4: Web Main Page

Main Menu

Via the Web Management, the administrator can set up the Modbus Gateway by selecting the functions that are listed in the Main Function. The screen in [Figure 4-1-5](#) appears.



Figure 4-1-5: Modbus Gateway Main Functions Menu

Object	Description
• Basic	The essential device information of Modbus Gateway.
• Accessible IP	To configure IP addresses lists to prevent unauthorized access.
• Network	To configure IP address information of Modbus Gateway.
• Modbus Gateway	To configure serial port value and port mode of Modbus Gateway.
• SNMP	To configure SNMP information of Modbus Gateway.
• Maintenance	The management of Modbus Gateway.
• Save and Restart	Save the configuration and reboot device.
• 	Refresh the page
• 	Log out the Modbus Gateway.

4.2 System

Use the System menu items to display and configure basic administrative details of the Modbus Gateway. Under the System, the following topics are provided to configure and view the system information. This section has the following items:

- **System** The Modbus Gateway system information is provided here.
- **Port** This page displays status of each port.
- **Device** Configure device name and syslog server on this page.
- **Time** Configure NTP server or manually adjust time on this page.
- **Console** Configure management methods on this page.
- **Email** Set up the SMTP mail parameters for further operation of events.

4.2.1 System

The System page provides basic information for the current device. System page helps an administrator to identify software version, system uptime and IP address information. The screen in [Figure 4-2-1](#) appears.

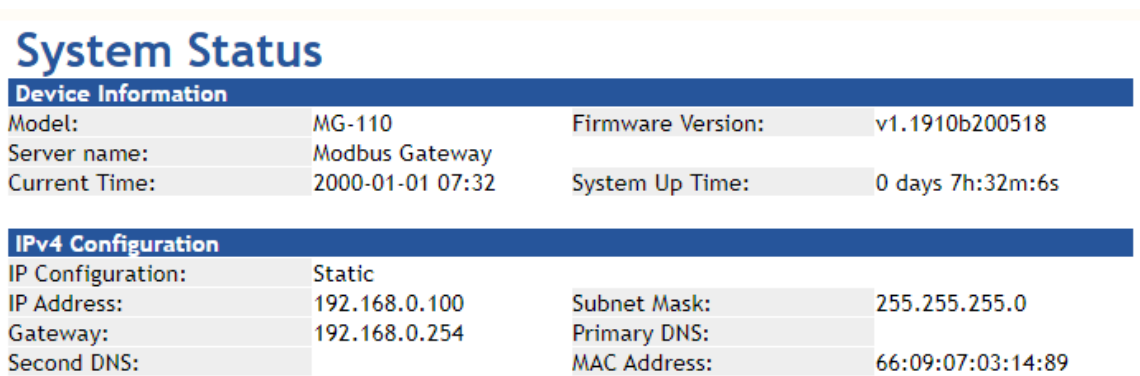

System Status			
Device Information			
Model:	MG-110	Firmware Version:	v1.1910b200518
Server name:	Modbus Gateway		
Current Time:	2000-01-01 07:32	System Up Time:	0 days 7h:32m:6s
IPv4 Configuration			
IP Configuration:	Static		
IP Address:	192.168.0.100	Subnet Mask:	255.255.255.0
Gateway:	192.168.0.254	Primary DNS:	
Second DNS:		MAC Address:	66:09:07:03:14:89

Figure 4-2-1: System Status Page Screenshot

The page includes the following fields:

Device Information

Object	Description
• Model	Specifies the device model name.
• Firmware Version	The firmware version of Modbus Gateway.
• Server Name	The system name configured in Basic/Device Name.
• Current Time	The current (GMT) system time and date.
• System Up Time	The period of time the device has been operational.

IPv4 Configuration

Object	Description
• IP Configuration	The status of IPv4 configuration.
• IP Address	The current IPv4 address of the device.
• Subnet Mask	The current IPv4 subnet mask of the device.
• Gateway	The current IPv4 gateway of the device.
• Primary DNS	The current first DNS server of the device.
• Second DNS	The current second DNS server of the device.
• MAC Address	Specifies the device MAC address.

4.2.2 Port

This Port page displays the status of each port, including operation mode and serial settings. The screen in [Figure 4-2-2](#) appears.

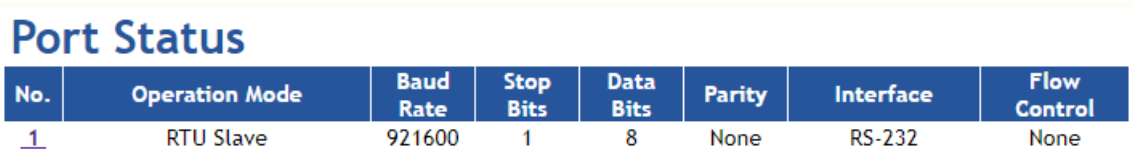

No.	Operation Mode	Baud Rate	Stop Bits	Data Bits	Parity	Interface	Flow Control
<u>1</u>	RTU Slave	921600	1	8	None	RS-232	None

Figure 4-2-2: Port Status Page Screenshot

The following column shows the Port statuses:

Object	Description
• No.	The serial number (No.) indicates port number. It can be directly linked to the corresponding page settings.
• Operation Mode	The current operation mode of Modbus Gateway.
• Baud Rate	The rate of data transmission to and from the attached modbus serial device.
• Stop Bits	The stop bit follows the data and parity bits in serial communication. It indicates the end of transmission. The default is 1 .
• Data Bits	Indicates the number of the bits in a transmitted data package. The default is 8 .
• Parity	Checks for the parity type. The default value is none .
• Interface	The device server supports three interfaces. The default value is RS-232 . <ul style="list-style-type: none"> ■ RS-232 ■ RS-422 ■ RS-485 2-Wire ■ RS-485 4-Wire
• Flow Control	The method is used to suspend and resume data transmission to ensure that data is not lost. The default value is none .

4.2.3 Device

This page provides configuration of device name and syslog server. The screen in [Figure 4-2-3](#) appears.

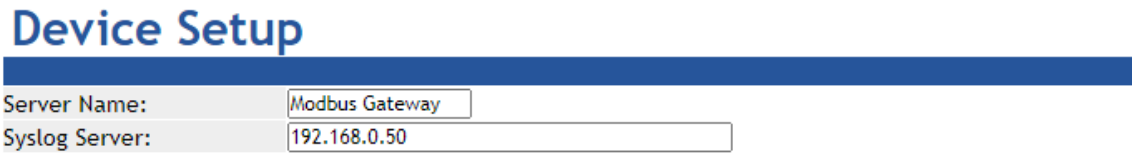

Figure 4-2-3: Device Setup Page Screenshot

The page includes the following fields:

Object	Description
• Server Name	To configure the name of server. The default value is Server .
• Syslog Server	To configure IP address of syslog server.



When applying any configuration changes of Modbus Gateway, it's required to **save changed configuration and reboot system**. Therefore the new configuration will be applied after rebooting.

4.2.4 Time

This page provides configuration of NTP server and Time modification. The screen in [Figure 4-2-4](#) appears.

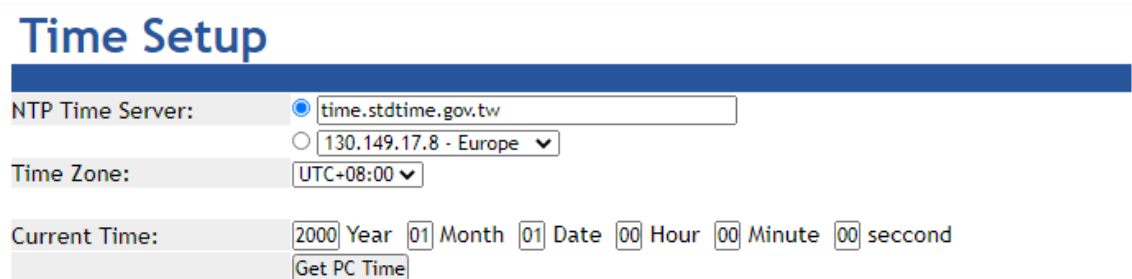

Figure 4-2-4: Time Setup Page Screenshot

The page includes the following fields:

Object	Description
• NTP Time Server	To configure NTP server for time synchronization. The default is time.stdtime.gov.tw .
• Time Zone	Lists various Time Zones worldwide. Select appropriate Time Zone from the drop-down menu and click Save to set.
• Current Time	To manually set the Year / Mouth / Day/ Hour / Minute / Second or get time from PC in this page.

4.2.5 Console

This page is to configure management methods for web and remote console. The screen in [Figure 4-2-5](#) appears.



Figure 4-2-5: Console Setup Page Screenshot

The page includes the following fields:

Object	Description
• Web Console	To enable or disable access to the web console. The default is Enable .
• Remote Console	To enable or disable access to the remote console. The default is Enable .
• Current Time	To check whether the reset button is working or not. The default is No .

4.2.6 Email

The page shows SMTP configuration. The screen in [Figure 4-2-6](#) appears. You may set up SMTP mail parameters for further operation. If users want to send the alarm message out that contains “Log-Fail Warring”, it will need to configure parameters here.

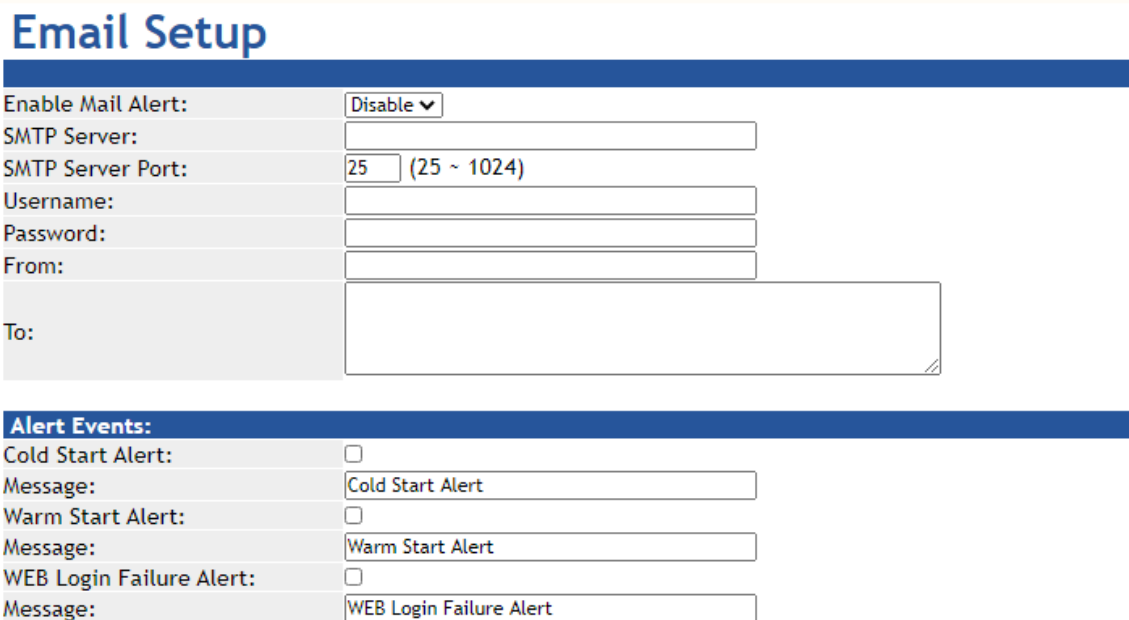

Figure 4-2-6: SMTP Setup Page Screenshot

The page includes the following fields:

Object	Description
• Enable Mail Alert	To Enable SMTP function. The default value is "Disable".
• SMTP Server	Set port number of SMTP service. The default number is "25".
• SMTP Server Port	Type the SMTP server name or the IP address of the SMTP server address.
• SMTP Login Information	Username: Enter your login name for the SMTP Server. Password: Enter your password for the SMTP Server.
• From	Enter the sender's e-mail address. This address is used for replying e-mails.
• To	Enter the receiver's e-mail address.

Alert Events:

Object	Description
• Cold Start Alert	To Enable the Cold Start Alert. The default value is "Disable". Message: Enter the message of the e-mail. The default subject is " Cold Start Alert ".
• Warm Start Alert	To Enable the Warm Start Alert. The default value is "Disable". Message: Enter the message of the e-mail. The default subject is " Warm Start Alert ".
• WEB Login Failure Alert	To Enable the WEB Login Failure Alert. The default value is "Disable". Message: Enter the message of the e-mail. The default subject is " WEB Login Failure Alert ".

4.3 Accessible IP

This page provides the specified IP address to connect with Modbus Gateway. When the list of accessible IP is enabled, only IP address in the list can connect to device. When the function is disabled, there is no such restriction. The list allows user to configure up to four IP groups. The accessible IP setup screen in [Figure 4-3-1](#) appears.

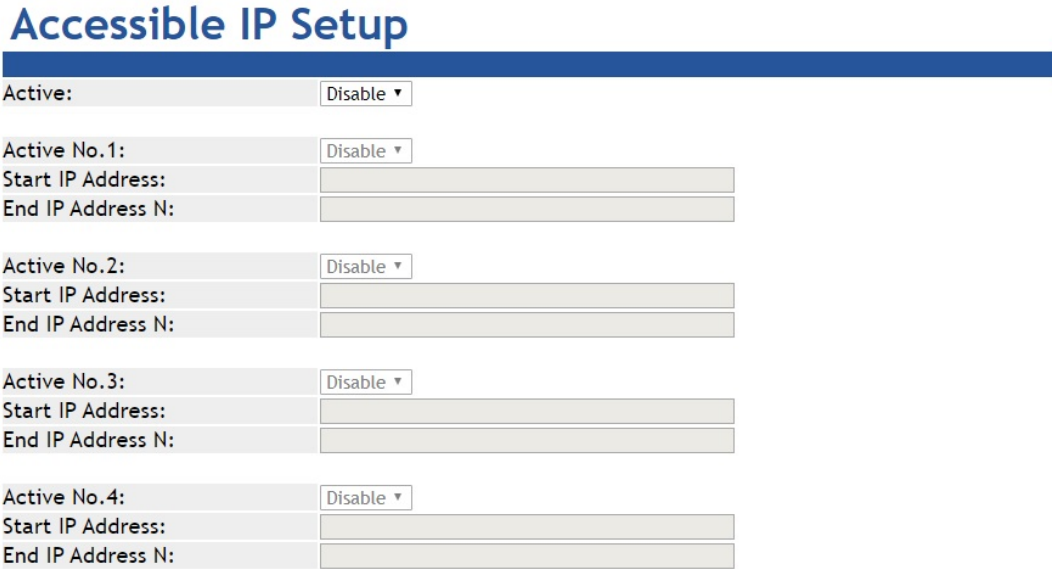

Figure 4-3-1: Accessible IP Setup Page Screenshot

The page includes the following fields:

Object	Description
<ul style="list-style-type: none"> Active 	Configure the accessible IP list. Possible modes are: Disabled: Disable accessible IP lists. Enabled: Enable accessible IP lists.
<ul style="list-style-type: none"> Activate NO 	Enable or disable activated IP groups.
<ul style="list-style-type: none"> Start IP Address 	Enter the IP address for starting.
<ul style="list-style-type: none"> End IP Address N 	Enter the IP address for ending

Example

Allowed hosts	Start: IP Address setting	End: IP Address N
<ul style="list-style-type: none"> Any host 	disable	disable
<ul style="list-style-type: none"> 192.168.0.120 	192.168.0.120	
<ul style="list-style-type: none"> 192.168.0.1 to 192.168.0.254 	192.168.0.1	192.168.0.254

4.4 Network

This page allows the user to configure IPv4 or IPv6 address. The IP configuration screen in [Figure 4-4-1](#) appears.

IP Configuration

IPv4 Configuration	
IP Configuration:	Static ▾
IP Address:	192.168.0.100
Subnet Mask:	255.255.255.0
Gateway:	192.168.0.254
Primary DNS:	
Second DNS:	

Figure 4-4-1: IP Configuration Page Screenshot

The page includes the following fields:

IPv4

Object	Description
<ul style="list-style-type: none"> • IP Configuration 	Configure static or DHCP to get IPv4 address. The default value is static . <ul style="list-style-type: none"> ■ static: Set a fixed IPv4 address that was manually configured for a device ■ DHCP: Set IPv4 address automatically assigned from a DHCP server.
<ul style="list-style-type: none"> • IP Address 	The current IPv4 Address of the device. The IP Address could be manually assigned. The default value is 192.168.0.100 .
<ul style="list-style-type: none"> • Subnet Mask 	The current IP subnet mask of the device. The default value is 255.255.255.0 .
<ul style="list-style-type: none"> • Gateway 	The default gateway for the IP interface. The default value is 192.168.0.254 .
<ul style="list-style-type: none"> • Primary DNS 	Configure the first DNS server.
<ul style="list-style-type: none"> • Second DNS 	Configure the second DNS server.

4.5 Modbus Gateway

The following figure shows port settings. Note that these settings need to match the parameters on serial port of the Modbus device. Each parameter is described in details in the following section. The port configuration screen in [Figure 4-5-1](#) appears.

Port 1 Setup

Operation Mode:	<input type="text" value="RTU Slave"/>	Baud Rate:	<input type="text" value="921600"/>
Data Bits:	<input type="text" value="8"/>	Any Baud Rate:	<input type="text" value="50"/> (50 - 921600)
Stop Bits:	<input type="text" value="1"/>	Parity:	<input type="text" value="None"/>
Interface:	<input type="text" value="RS-232"/>	Flow Control:	<input type="text" value="None"/>
RTS ON delay:	<input type="text" value="0"/> (0-100ms)	RTS OFF delay:	<input type="text" value="0"/> (0-100ms)

Response Timeout: (10 - 120000ms)

Figure 4-5-1: Port Setup Page Screenshot

4.5.1 Serial setup

The serial setup screen is shown in [Figure 4-5-2](#).

Operation Mode:	<input type="text" value="Disable"/>	Baud Rate:	<input type="text" value="921600"/>
Data Bits:	<input type="text" value="8"/>	Any Baud Rate:	<input type="text" value="50"/> (50 - 921600)
Stop Bits:	<input type="text" value="1"/>	Parity:	<input type="text" value="None"/>
Interface:	<input type="text" value="RS-232"/>	Flow Control:	<input type="text" value="None"/>
RTS ON delay:	<input type="text" value="0"/> (0-100ms)	RTS OFF delay:	<input type="text" value="0"/> (0-100ms)

Response Timeout: (10 - 120000ms)

Figure 4-5-2: Serial Setup Page Screenshot

Object	Description
<ul style="list-style-type: none"> • Operation Mode 	Used to set Modbus/serial on serial port. The Default is RTU Slave . <ul style="list-style-type: none"> ■ Disable ■ RTU Slave, ■ RTU Master, ■ ASCII Slave ■ ASCII Master
<ul style="list-style-type: none"> • Baud Rate 	The rate of data transmission to and from the attached serial device. It allows 50 bps to 921600 bps. The default is 921600 bps .
<ul style="list-style-type: none"> • Stop Bits 	The stop bit follows the data and parity bits in serial communication. It indicates the end of transmission. The default is 1.
<ul style="list-style-type: none"> • Data Bits 	Indicates the number of the bits in a transmitted data package. The allowed value is 5,6,7,8 and default value is 8.
<ul style="list-style-type: none"> • Parity 	This parameter controls the error checking mode. It support five modes and default value is none .

	<ul style="list-style-type: none"> ■ Even ■ Odd ■ None ■ Space ■ Mark
• Interface	<p>The device server supports three interfaces. The default value is RS-232.</p> <ul style="list-style-type: none"> ■ RS-232 ■ RS-422 ■ RS-485 2-Wire ■ RS-485 4-Wire
• Flow Control	<p>The method is used to suspend and resume data transmission to ensure that data is not lost. It supports four methods and default value is none.</p> <ul style="list-style-type: none"> ■ None ■ RTS/CTS ■ Xon/Xoff ■ DTR/DSR
• RTS ON delay	This parameter controls RTS turn on before data transmission.
• RTS OFF delay	This parameter controls RTS turn off after the transmission completes.
• Response Timeout	This parameter is used to configure how long the gateway will wait for a response from a Modbus ASCII or RTU slave.

4.5.2 Operation mode

The Modbus Gateway makes connected Serial equipment become IP-based. That also makes them able to connect to a TCP/IP networking immediately. The Modbus Gateway allows traditional Computer/Client COM ports access to a serial equipment anywhere on the Ethernet LAN network.

This operation mode can be set up as **Disable**, **RTU Slave/Master** and **ASCII Slave/Master**. The operation mode screen in [Figure 4-5-3](#) appears.

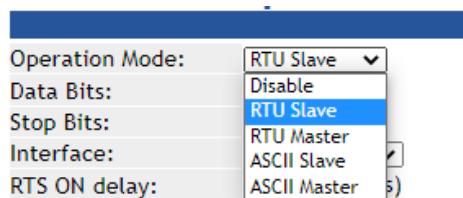

Figure 4-5-3: Operation Mode Screenshot

4.5.2.1 Disable mode

When selecting disabled operation mode, the device port can be disabled. The disable mode screen in [Figure 4-5-4](#) appears.

Operation Mode:	Disable	Baud Rate:	921600
Data Bits:	8	Any Baud Rate:	50 (50 - 921600)
Stop Bits:	1	Parity:	None
Interface:	RS-232	Flow Control:	None
RTS ON delay:	0 (0-100ms)	RTS OFF delay:	0 (0-100ms)

Response Timeout: 1000 (10 - 120000ms)

Figure 4-5-4: Disable Mode Screenshot

Buttons

: Click to apply port config changes.



When applying any configuration changes of Modbus Gateway, it's required to **save changed configuration and reboot system**. Therefore the new configuration will be applied after rebooting.

4.5.2.2 RTU Slave mode

This function allows the users to use Modbus TCP master device and Modbus RTU device to achieve communication. The operation mode of the Industrial Modbus Gateway is set to RTU Slave. The remote pair master/slave topology in [Figure 4-5-5](#) appears.

RTU Slave mode



Figure 4-5-5: RTU Slave Topology

The remote pair master mode screenshot in [Figure 4-5-6](#) appears.

Operation Mode:	RTU Slave	Baud Rate:	921600
Data Bits:	8	Any Baud Rate:	50 (50 - 921600)
Stop Bits:	1	Parity:	None
Interface:	RS-232	Flow Control:	None
RTS ON delay:	0 (0-100ms)	RTS OFF delay:	0 (0-100ms)

Response Timeout: 1000 (10 - 120000ms)

Figure 4-5-6: RTU Slave Mode Screenshot

4.5.2.3 RTU Master mode

This function allows the users to use Modbus RTU master device and Modbus TCP device to achieve communication. The operation mode of the Industrial Modbus Gateway is set to RTU Master. The serial telnet mode topology in [Figure 4-5-7](#) appears.

RTU Master mode



Figure 4-5-7: RTU Master Mode Topology

The serial Telnet mode screenshot in [Figure 4-5-8](#) appears.

Operation Mode:	RTU Master	Baud Rate:	921600
Data Bits:	8	Any Baud Rate:	50 (50 - 921600)
Stop Bits:	1	Parity:	None
Interface:	RS-232	Flow Control:	None
RTS ON delay:	0 (0-100ms)	RTS OFF delay:	0 (0-100ms)

Response Timeout: 1000 (10 - 120000ms) Auto Detect

Figure 4-5-8: RTU Master Mode Screenshot

4.5.2.4 ASCII Slave mode

This function allows the users to use Modbus TCP master device and Modbus ASCII device to achieve communication. The operation mode of the gateway is set to ASCII Slave. The TCP server mode topology in [Figure 4-5-9](#) appears.

ASCII Slave mode



Figure 4-5-9: ASCII Slave Mode Topology

The TCP server mode screenshot in [Figure 4-5-10](#) appears.

Operation Mode:	ASCII Slave	Baud Rate:	921600
Data Bits:	8	Any Baud Rate:	50 (50 - 921600)
Stop Bits:	1	Parity:	None
Interface:	RS-232	Flow Control:	None
RTS ON delay:	0 (0-100ms)	RTS OFF delay:	0 (0-100ms)

Response Timeout: 1000 (10 - 120000ms)

Figure 4-5-10: ASCII Slave Mode Screenshot

4.5.2.5 ASCII Master mode

This function allows the users to use Modbus ASCII master device and Modbus TCP device to achieve communication. The operation mode of the Industrial Modbus Gateway is set to ASCII Master. The TCP client mode topology in [Figure 4-5-11](#) appears.

ASCII Master mode



Figure 4-5-11: ASCII Master Mode Topology

The TCP client mode screenshot in [Figure 4-5-12](#) appears.

Operation Mode:	ASCII Master	Baud Rate:	921600
Data Bits:	8	Any Baud Rate:	50 (50 - 921600)
Stop Bits:	1	Parity:	None
Interface:	RS-232	Flow Control:	None
RTS ON delay:	0 (0-100ms)	RTS OFF delay:	0 (0-100ms)

Response Timeout: 1000 (10 - 120000ms)

Figure 4-5-12: ASCII Master Mode Screenshot

4.5.3 MB COM

This page is to create virtual COM port for Modbus gateway. The default is disable.

MB COM Setup

Active:

MB COM 1:

- Disable
- RTU Slave**
- RTU Master
- ASCII Slave
- ASCII Master

4.5.4 Modbus Config

4.5.4.1 Router

The Modbus Gateway support **four** Modbus masters in each serial port which can communicate with the Modbus slave devices. It can be connected to a serial port by IP address or TCP port. The screen in [Figure 4-5-14](#) appears.

Router Setup

Index	Local Interface	Local IP / TCP port	Destination
<input type="radio"/> 1			
<input type="radio"/> 2			
<input type="radio"/> 3			
<input type="radio"/> 4			

Apply

Local Interface:

Local IP Address:

Destination:

Figure 4-5-14: Router Status Page Screenshot

For example, IP address 192.168.0.60 is set and assigned to serial port 1. As shown below, it will forward directly to serial port 1 when you get a Modbus request that is sent to 192.168.0.60. The Router Setup screen in [Figure 4-5-15](#) appears.

Local Interface:

Local IP Address:

Destination:

Router Setup

Index	Local Interface	Local IP / TCP port	Destination
<input type="radio"/> 1	IP Address	192.168.0.60	Port 1
<input type="radio"/> 2			
<input type="radio"/> 3			
<input type="radio"/> 4			

Figure 4-5-15: Router Setup Page Screenshot

The page includes the following fields:

Object	Description
<ul style="list-style-type: none"> • Operation Mode 	<p>Used to set Modbus/serial on serial port. The Default is RTU Slave.</p> <ul style="list-style-type: none"> ■ Disable ■ RTU Slave, ■ RTU Master, ■ ASCII Slave ■ ASCII Master
<ul style="list-style-type: none"> • Baud Rate 	<p>The rate of data transmission to and from the attached serial device. It allows 50 bps to 921600 bps. The default is 921600 bps.</p>
<ul style="list-style-type: none"> • Stop Bits 	<p>The stop bit follows the data and parity bits in serial communication. It indicates the end</p>

	of transmission. The default is 1.
• Data Bits	Indicates the number of the bits in a transmitted data package. The allowed value is 5,6,7,8 and default value is 8.

4.5.4.2 Mapping

The ID Mapping Setup is a routing mechanism for gateway. It can follow routing rule on this table to transfer Modbus request to the specific serial port or TCP server that connects the Modbus slave device. The screen in [Figure 4-5-16](#) appears.

ID Mapping Setup

Auto Device Routing Disable ▾ Page 1 ~ 20 ▾

Index	Router	Type	Slave ID Mapping (Virtual<=>Real)	Destination
<input type="radio"/> 1				
<input type="radio"/> 2				
<input type="radio"/> 3				
<input type="radio"/> 4				
<input type="radio"/> 5				
<input type="radio"/> 6				
<input type="radio"/> 7				
<input type="radio"/> 8				
<input type="radio"/> 9				
<input type="radio"/> 10				
<input type="radio"/> 11				
<input type="radio"/> 12				
<input type="radio"/> 13				
<input type="radio"/> 14				
<input type="radio"/> 15				
<input type="radio"/> 16				
<input type="radio"/> 17				
<input type="radio"/> 18				
<input type="radio"/> 19				
<input type="radio"/> 20				

Figure 4-5-16: Mapping Status Page Screenshot

In block 1, it's a setting value for slave ID 1~3 that will forward to serial port 1. When you get a Modbus requests with slave ID 1~3, it will follow this rule to be routed to the targeted Modbus slave device. In block 2, you can select the one to add, edit or delete the rule on the table. The block 1 and block 2 screen in [Figure 4-5-17](#) appears.

ID Mapping Setup

Auto Device Routing Disable ▾ Page 1 ~ 20 ▾

Index	Router	Type	Slave ID Mapping (Virtual<=>Real)	Destination
<input type="radio"/> 1	Manual	Serial	1-3<=>1-3	Port 1
<input type="radio"/> 2				
<input type="radio"/> 3				

Block 1

Type: TCP Address ▾

Slave ID From: To

Slave ID Offset:

Destination: :

Block 2

Figure 4-5-17: The Block 1 / Block 2 Screenshot

Basic setting

A Modbus device with slave ID 1 can be set to be connected to serial port 1 as shown in [Figure 4-5-18](#)

Type:
 Slave ID From: To
 Slave ID Offset:
 Destination:

ID Mapping Setup

Auto Device Routing		<input type="button" value="Enable"/> <input type="button" value="v"/>		Page		<input type="text" value="1 ~ 20"/> <input type="button" value="v"/>	
	Index	Router	Type	Slave ID Mapping (Virtual<=>Real)	Destination		
<input type="radio"/>	1	Manual	Serial	1-1<=>1-1	Serial 1		
<input type="radio"/>	2						

Figure 4-5-18: Basic setting of Mapping Screenshot

Auto Device Routing

It's a mechanism that will help you find where it is and get routed correctly on serial port. So users don't need to set the rule manually. If the Auto Device Routing is enabled, it will clear Slave ID Mapping value of the rule with serial port automatically.

ID Mapping Setup

Auto Device Routing		<input type="button" value="Enable"/> <input type="button" value="v"/>		Page		<input type="text" value="1 ~ 20"/> <input type="button" value="v"/>	
	Index	Router	Type	Slave ID Mapping (Virtual<=>Real)	Destination		
<input type="radio"/>	1	Manual	Serial	0-0<=>0-0	Serial 1		
<input type="radio"/>	2						

When you get a request with slave ID didn't exist on rule table. It will detect all serial port to find the target device and add on the rule table directly.

ID Mapping Setup

Auto Device Routing		<input type="button" value="Enable"/> <input type="button" value="v"/>		Page		<input type="text" value="1 ~ 20"/> <input type="button" value="v"/>	
	Index	Router	Type	Slave ID Mapping (Virtual<=>Real)	Destination		
<input type="radio"/>	1	Manual	Serial	0-0<=>0-0	Serial 1		
<input type="radio"/>	2	Auto	Serial	1-1<=>1-1	Serial 2		

If there are two target devices with the same ID in two serial ports, it will show conflict. Check environment please.

ID Mapping Setup

Auto Device Routing		Enable ▾		Page		1 ~ 20 ▾	
	Index	Router	Type	Slave ID Mapping (Virtual<=>Real)	Destination		
<input type="radio"/>	1	Manual	Serial	0-0<=>0-0	Serial 1		
<input type="radio"/>	2	Auto	Serial	2-2<=>2-2	Serial 1		
<input type="radio"/>	3	Auto	Serial	2-2<=>2-2	Serial 2 , Conflict		
<input type="radio"/>	4						

4.5.4.3 Parameters

This function allows setting the value for serial port COM configuration. Press the “Apply” button to set the value and the screen in [Figure 4-5-19](#) appears

Parameters Setup

Initial Delay:	<input type="text" value="0"/>	(0-30000ms)
Listen Port:	<input type="text" value="502"/>	(1 - 65535)
TCP Exception:	<input type="text" value="Disable"/>	▾
TCP Timeout:	<input type="text" value="1000"/>	(10 - 120000ms)

Figure 4-5-19: Parameters Setup Page Screenshot

The page includes the following fields:

Object	Description
• Initial Delay	You can make the IP218 wait for some Modbus slave devices may take more time to boot up. It will force the IP218 to wait the initial delay setting before booting completes.
• Listen Port	This parameter (default:502) means the TCP port t communicates with the connected device.
• TCP Exception	If this setting is enabled, IP218 will return an exception in response when there is no response from the slave. If it's disabled, it will do nothing when there is no response.
• TCP Timeout	This parameter (default:1000) is used to configure how long IP218 will wait for a response from a Modbus TCP slave. If there is no response from the slave, the master will ignore and continue next step. This makes the Modbus system work improperly even if a Modbus slave device is faulty.

4.5.5 Priority Control

It's a mechanism that Modbus Messaging Priority Control can make a certain requests for more immediate response times. It will be arranged to the front of queue to be sent when Modbus gateway detects a priority request

4.5.5.1 Master

The priority rule can be assigned by master (serial port or IP address). As above, it means the request from serial port 1 or 192.168.0.123 will be considered a priority request. The screen in [Figure 4-5-20](#) appears

Master Control

Specified Masters: ▾

	Index	Type	Definition
<input type="radio"/>	1	Serial Port	Serial 1
<input type="radio"/>	2	IP Address	192.168.0.123

Type: ▾

IP Address:

Figure 4-5-20: Master Setup Page Screenshot

4.5.5.2 TCP

It is the same as priority master shown above, it means the request from port 1024 will be high priority. The screen in [Figure 4-5-21](#) appears.

TCP Control

Specified TCP Port: ▾

TCP Port: (1024-65535)

Figure 4-5-21: TCP Setup Page Screenshot

4.5.5.3 Request

The command type can also be made a priority request. Like the above, as requested by slave ID 3, function code 3 and data 00 00 00 03 will be high priority. The screen in [Figure 4-5-22](#) appears.

Request Control

Specified Request: ▾

	Index	Slave ID	Function Code	Data
<input type="radio"/>	1	3	3	00-00-00-03
<input type="radio"/>	2			
<input type="radio"/>	3			
<input type="radio"/>	4			

Slave ID:

Function Code:

Data (Format in Hex): (ex. 01-3a-b5)

Figure 4-5-22: Request Setup Page Screenshot

4.6 SNMP Setup

Use the Port Menu to display or configure the Modbus Gateway's ports. This section includes the page that displays current port configurations. Ports can also be configured here. The Port Configuration screen in [Figure 4-6-1](#) appears.

SNMP Setup

SNMP Active:	Disable ▾
Community:	public
Contact:	defaultContact
Location:	defaultLocation
Trap Server:	localhost IP or domain name

Events:

Cold Start Trap:	<input type="checkbox"/>
Warm Start Trap:	<input type="checkbox"/>
Authentication Failure Trap:	<input type="checkbox"/>

Figure 4-6-1: SNMP Setup page Screenshot

The page includes the following fields:

Object	Description
• SNMP Active	Indicates the SNMP mode operation. Possible modes are: <ul style="list-style-type: none"> ■ Disable: Disable SNMP mode operation. ■ Enable: Enable SNMP mode operation.
• Community	Indicates the security name to map the community to the SNMP Groups configuration.
• Contact	The textual identification of the contact person for this managed node, together with information on how to contact this person.
• Location	The physical location of this node (e.g., telephone closet, 3rd floor).
• Trap Server	Indicates the SNMP trap destination address. It allows a valid IP address or domain name.

Events

Object	Description
• Cold Start Trap	This event is triggered when the power is interrupted and restarted.
• Warm Start Trap	This event occurs when the device is reset but does not turn off the power.
• Authentication Failure Trap	This event occurs when an incorrect or unauthorized password are entered.

4.7 Maintenance

Use the Port Menu to display or configure the Modbus Gateway's ports. This section includes the page that displays current port configurations. Ports can also be configured here.

4.7.1 Change Password

After logging in to the Modbus Gateway, user can make changes from the "Change Password" page. The Change Password screen in [Figure 4-7-1](#) appears.



Figure 4-7-1: Change Password Page Screenshot

The page includes the following fields:

Object	Description
• New Password	A new password. It allows strings like A-Z, a-z, _ ,0-9
• Confirm Password	Please enter the user's new password here again to confirm.

4.7.2 Load Default

A user can reset the configuration of the Modbus Gateway on this page. The new configuration will be applied after restarting system. The Load Default screen in [Figure 4-7-2](#) appears.



Figure 4-7-2: Reset to Default Page Screenshot

Buttons

 : Click to reset to default.

Users can also export or import configuration settings of the Modbus Gateway on this page. The old configuration will be applied after import the config. The Export or Import Setting screen in [Figure 4-7-3](#) appears.

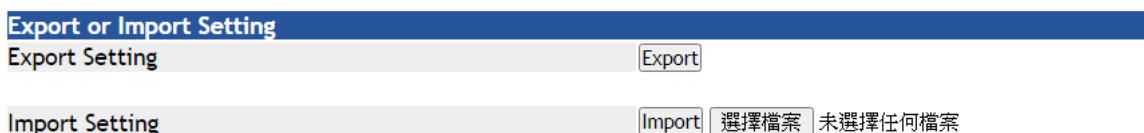

Figure 4-7-3: Export or Import Setting Page Screenshot

4.7.3 Firmware Update

This page facilitates an update of the firmware controlling the switch. The Firmware Update screen in [Figure 4-7-4](#) appears.

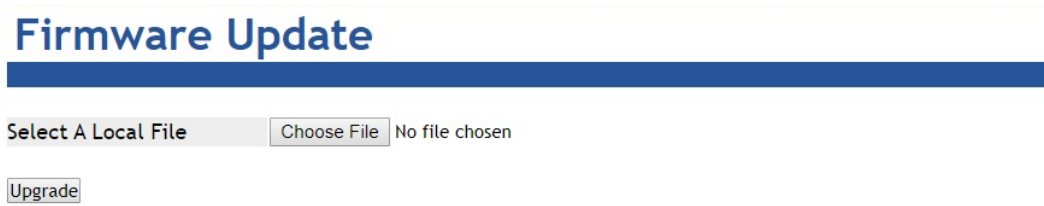

Figure 4-7-4: Firmware Update Page Screenshot

To open **Firmware Update** screen, perform the following:

1. Click **Maintenance -> Firmware Update**.
2. The Firmware Update screen is displayed as in [Figure 4-7-4](#).
3. Click the "**Choose File**" button of the Main page; the file selection menu pops up for you to choose firmware.
4. Select on the firmware and then click "**Upgrade**"; the **Software Upload Progress** would show the file with upload status.
5. Once the software is loaded to the system successfully, the following screen [Figure 4-7-5](#) appears. The system will load the new software after rebooting.

Information Note

Please wait while ...
System will reboot automatically after finished.

100 % , Rebooting ... 94 seconds

Figure 4-7-5: Rebooting Screenshot

4.8 Save and Restart

When applying any configuration changes of Modbus Gateway, it's required to save changed configuration and reboot system. Therefore the new configuration will be applied after rebooting. The Save and Restart screen in [Figure 4-8-1](#) appears.

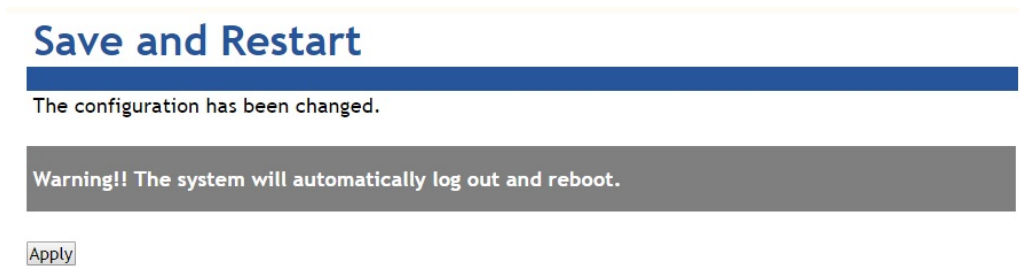



Figure 4-8-1 : Save and Restart Page Screenshot

Buttons

: Click to save changes and restart system.

5. SOFTWARE MB VCOM UTILITY

The "MB VCOM" Administration Suite provides you search function to find your MG-11x Modbus Gateway from a remote location. With MB VCOM Utility, you can easily install and search your MG-11x Modbus Gateway over the network. You can also run MB VCOM Utility from one location to manage multiple device servers. The setup program will be named **mbgsetup.exe**.

5.1 Installing the VCOM Utility

1. When you run MB VCOM installer, a welcome window will appear as shown in [Figure 5-1-1](#). Click Next to continue.

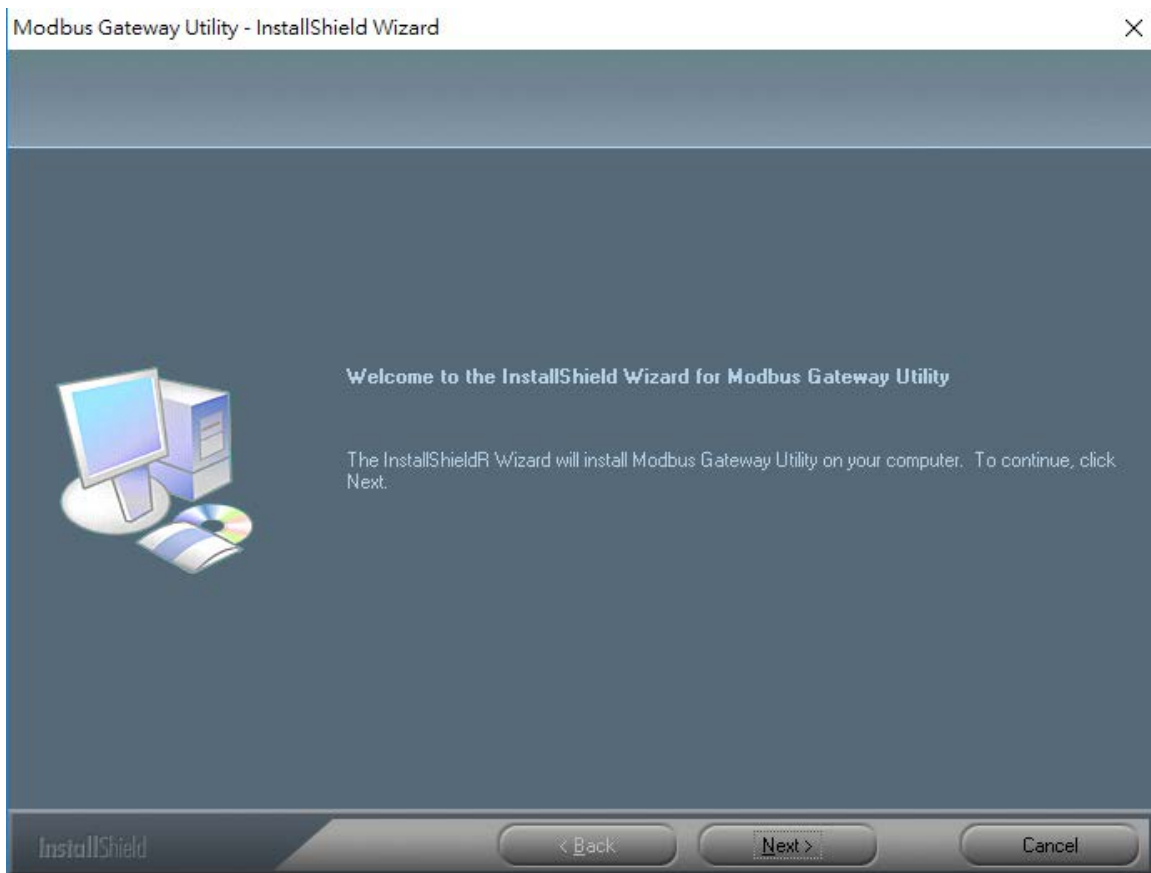

Figure 5-1-1 : Installing the VCOM Utility

2. Click Next to accept suggested installation path, or click browse to select a different location as shown in [Figure 5-1-2](#).

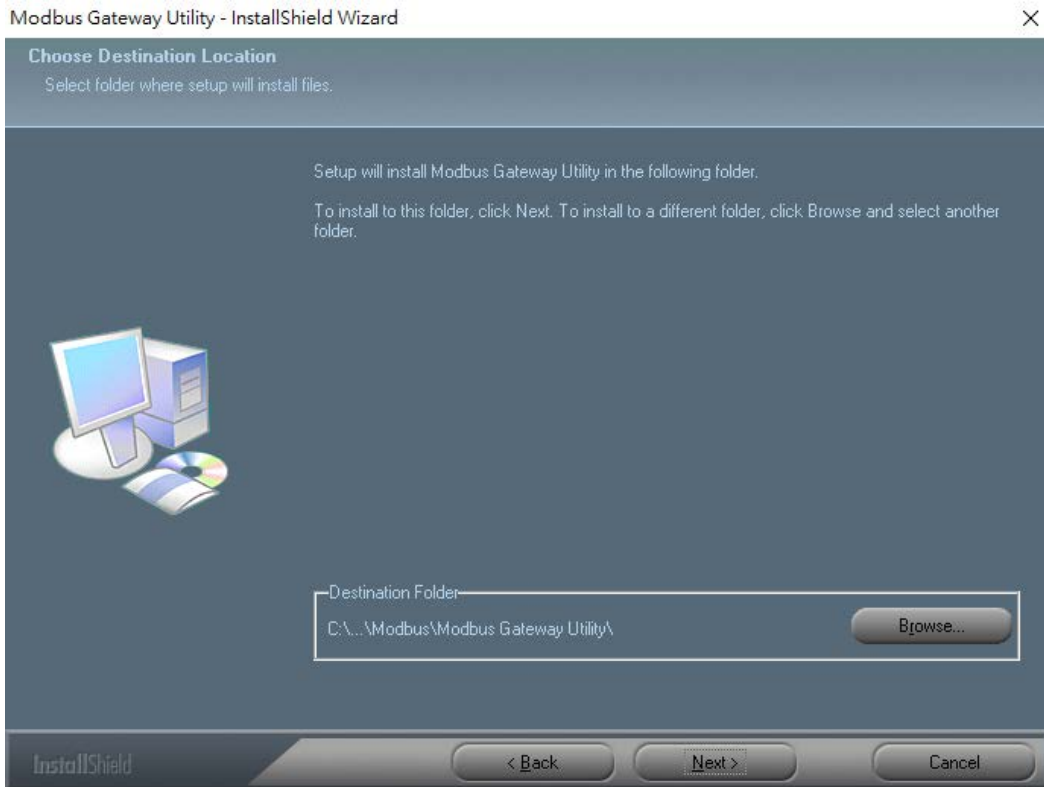

Figure 5-1-2 : Installing location

3. The setup wizard will show the progress of the installation and status as shown in [Figure 5-1-3](#).

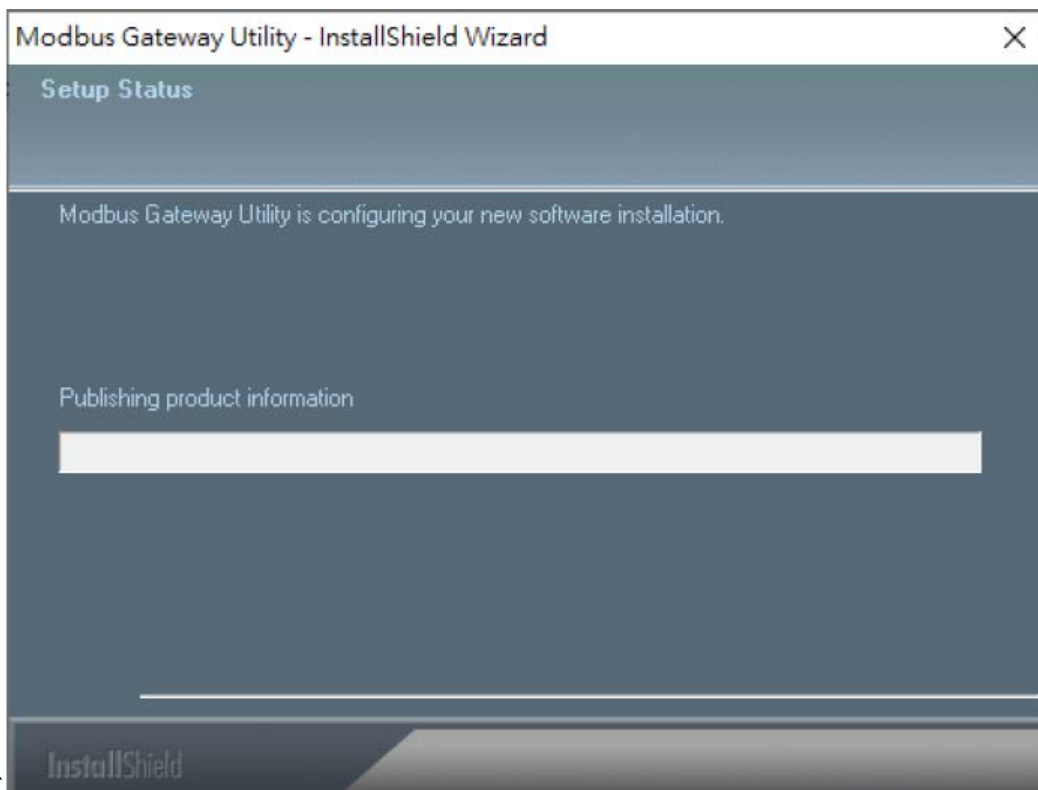

Figure 5-1-3 : Installing Process

4. Click Finish to successfully complete installation of VCOM software.as shown in [Figure 5-1-4](#).

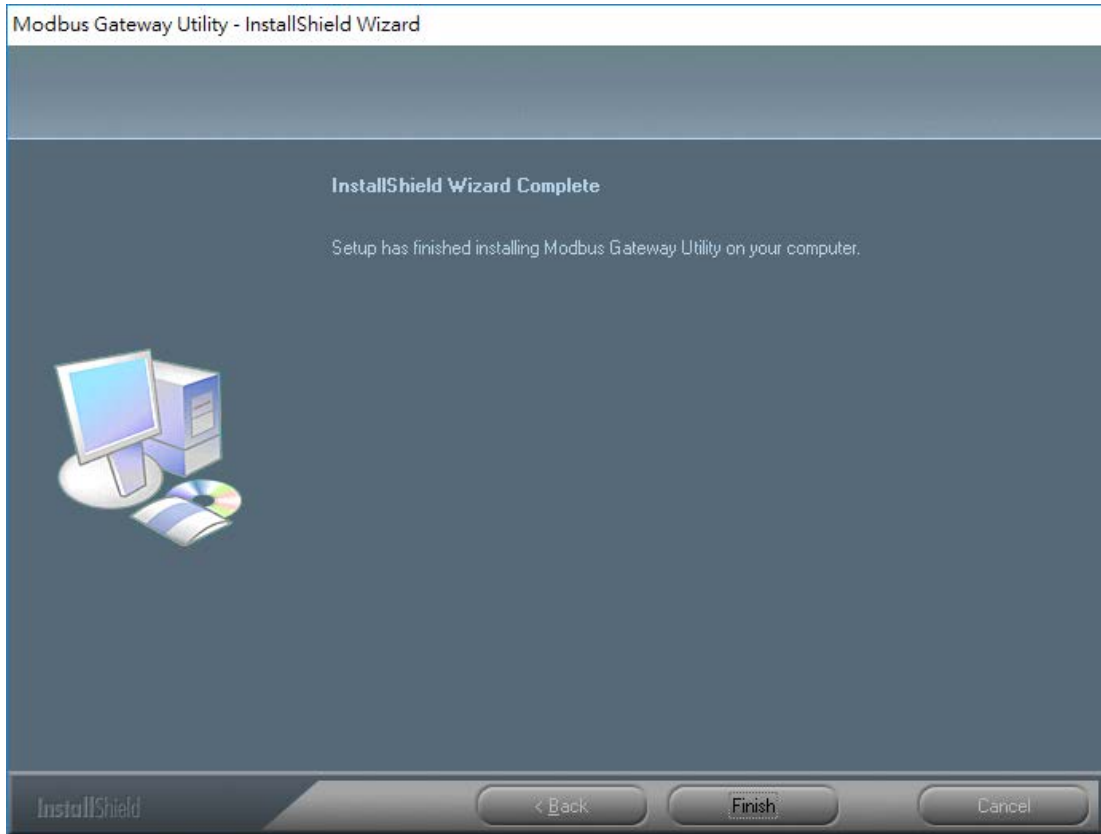

Figure 5-1-4 : Installation Finished

5. Restart computer as shown in [Figure 5-1-5](#).

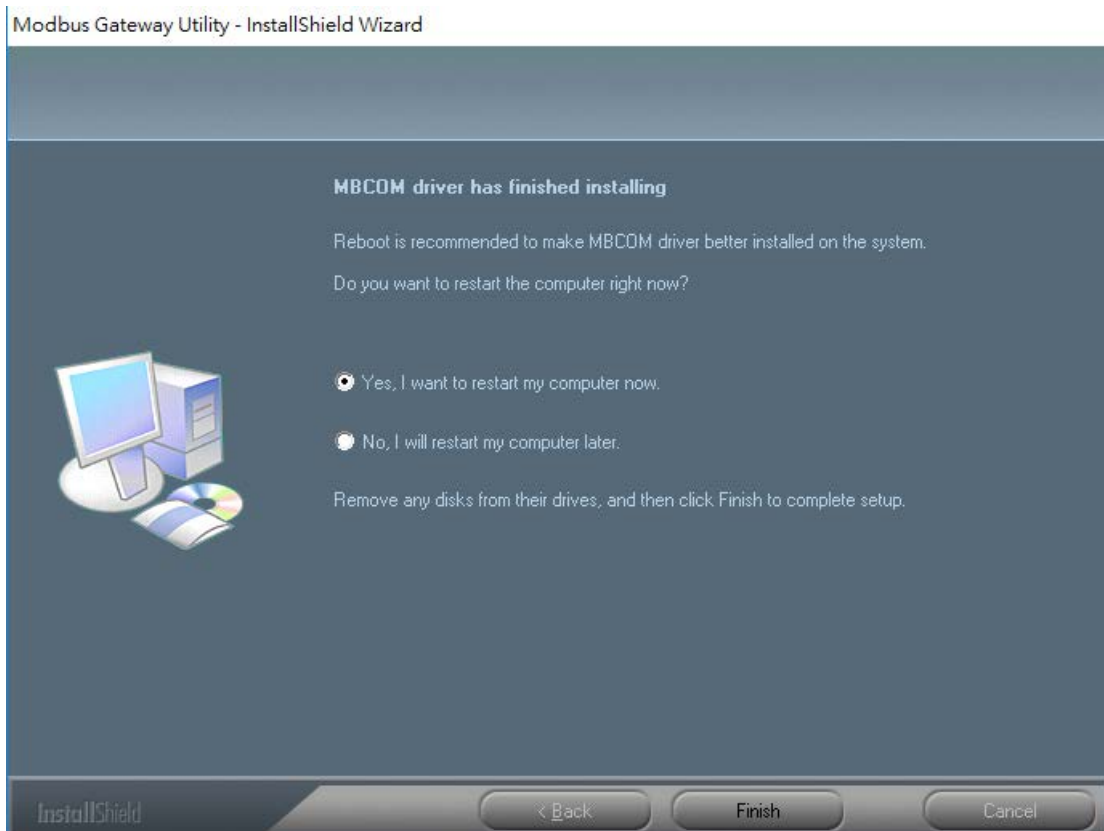

Figure 5-1-5 : Restart System

5.2 Search Devices

1. First click "Add Device" and then click "Search" if device has access to network, as shown in [Figure 5-2-1](#).

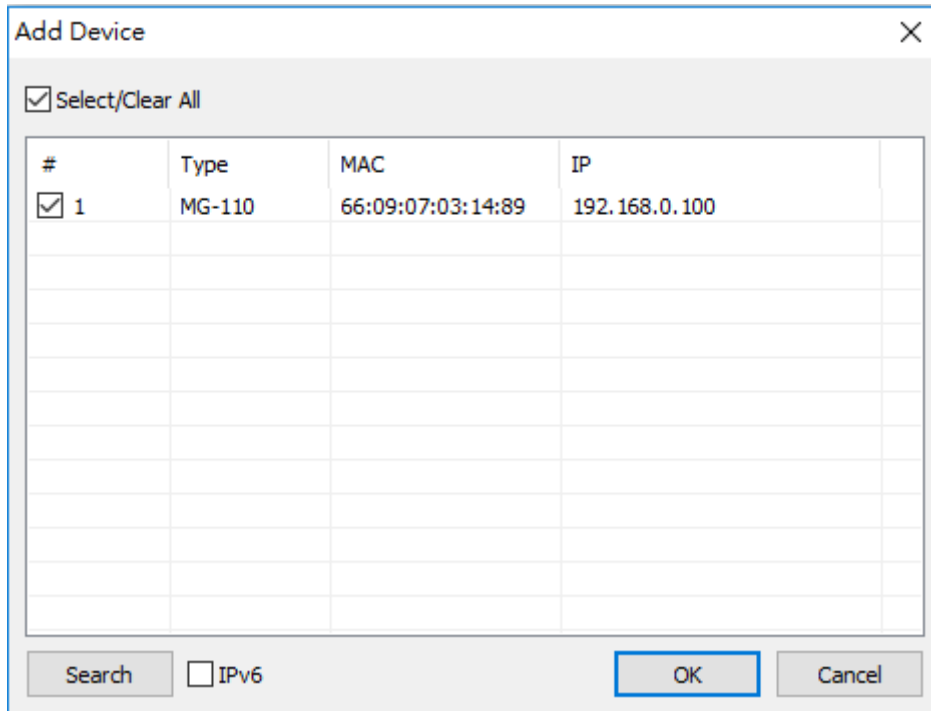

Figure 5-2-1 : Searching Devices

2. After adding an MG-110 device as shown in [Figure 5-2-2](#).

When you close searching window, it will add device automatically on main window. If you want to modify MG-110, please click "Open in Browser" to modify on web page.

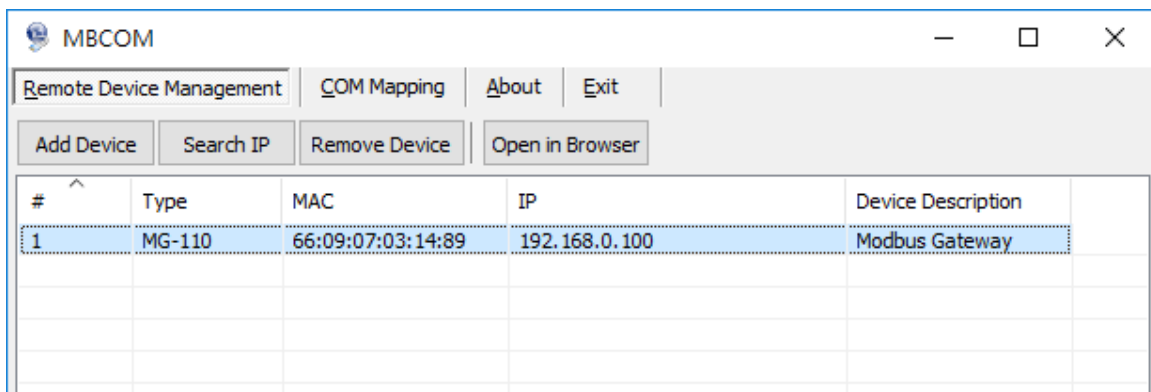

Figure 5-2-2: A device successfully added

5.3 COM Port Mapping

This function should be set as **VCOM mode** on the Modbus Gateway. VCOM software will create the corresponding virtual COM ports for com port mapping as shown in [Figure 5-3-1](#).

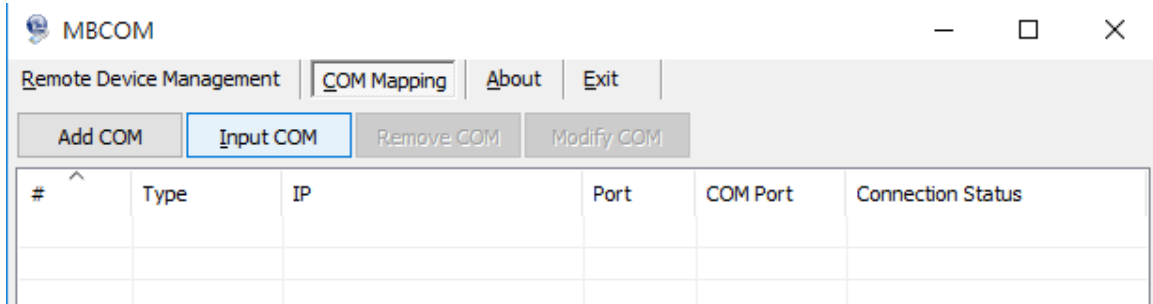

Figure 5-3-1 : VCOM software

Add Virtual COM port

1. Click "Search" to search the network for device servers.
2. Once a server has been found, select it to add it to the COM mapping list and Click "OK" to take effect as shown in [Figure 5-3-2](#).

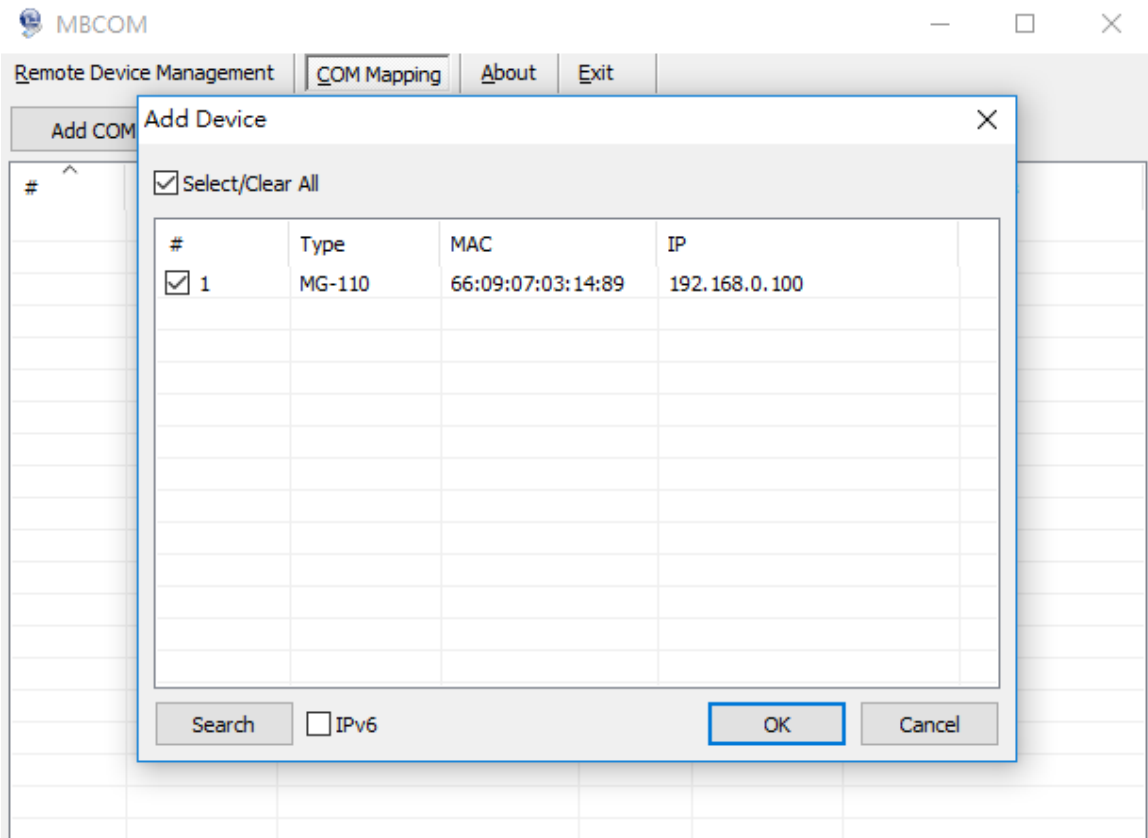

Figure 5-3-2 : VCOM software

3. Virtual com ports are generated as shown in [Figure 5-3-3](#).

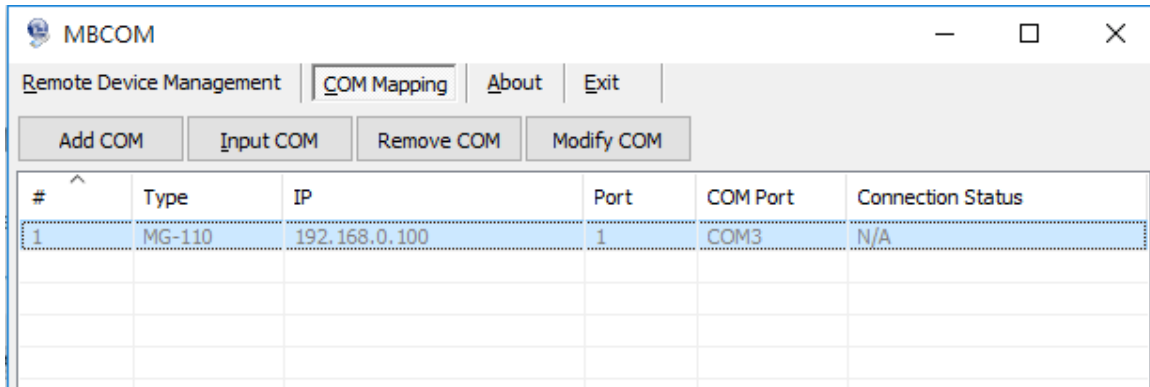

Figure 5-3-3 : Virtual COM Ports

4. From the Windows Device Manager, four COM Ports are added to the device list as shown in Figure 5-3-4.



Figure 5-3-4 : Virtual COM Ports