

**Industrial L3 Multi-Port Full Gigabit  
Managed Ethernet Switch**

**IGS-5225-8T2S2X/IGS-5225-8P2S2X**

Quick Installation Guide

# Table of Contents

1. Package Contents .....	3
2. Requirements .....	4
3. Wiring the Power Inputs.....	5
3.1 Grounding the Device.....	7
4. Terminal Setup .....	8
4.1 Logging on the Console.....	9
4.2 Configuring IP Address via Console .....	11
4.3 Storing the Current Switch Configuration .....	12
5. Starting Web Management .....	13
5.1 Logging in to the Industrial Managed Switch .....	13
5.2 Saving Configuration via Web .....	17
6. Resetting the Switch to Default.....	19
7. Customer Support .....	20

## 1. Package Contents

Thank you for purchasing PLANET L3 Industrial Managed Switch, IGS-5225-8T2S2X or IGS-5225-8P2S2X. The descriptions of these models are as follows:

IGS-5225-8T2S2X	Industrial L3 8-Port 10/100/1000T + 2-Port 1G/2.5G SFP + 2-Port 10G SFP+ Managed Ethernet Switch (-40~75 degrees C)
IGS-5225-8P2S2X	Industrial L3 8-Port 10/100/1000T 802.3at PoE + 2-Port 100/1G/2.5G SFP + 2-Port 10G SFP+ Managed Ethernet Switch (-40~75 degrees C)

“**Industrial Managed Switch**” mentioned in this Quick Installation Guide refers to the above two models.

Open the box of the **Industrial Managed Switch** and carefully unpack it. The box should contain the following items:

- The Industrial Managed Switch x 1
- QR Code Sheet x 1
- DIN-rail Kit x 1
- Wall Mounting Kit x 1
- RS232 Console Cable with DB9 to RJ45 Interface x 1
- Dust Cap (Please refer to the table below.)

Model	RJ45 Dust Cap	SFP Dust Cap
IGS-5225-8T2S2X	9	4
IGS-5225-8P2S2X		

If any of these are missing or damaged, please contact your dealer immediately. If possible, retain the carton including the original packing materials to enable you to repack the product in case there is a need to return it to us for repair.

## 2. Requirements

The Industrial Managed Switch provides remote login interface for management purposes. The following equipment is necessary for further management:

- Workstations running Windows 7/8/10/11, macOS 10.12 or later, Linux Kernel 2.6.18 or later, or other modern operating systems are compatible with TCP/IP Protocols.
- **Serial Port Connection** (Terminal)
  - The above Workstations come with COM Port (DB9) or USB-to-RS232 converter.
  - The above Workstations have been installed with terminal emulator, such as Hyper Terminal included in Windows XP/2003, putty or tera term.
  - Serial cable -- one end is attached to the RS232 serial port, while the other end to the console port of the Industrial Managed Switch.
- **Ethernet Port Connection**
  - Workstations are installed with Ethernet NIC (Network Interface Card)
  - Network cables -- Use standard network (UTP) cables with RJ45 connectors.
  - The above PC is installed with Web browser.



Note

It is recommended to use Google Chrome, Microsoft Edge or Firefox to access the Industrial Managed Switch. If the Web interface of the Industrial Managed Switch is not accessible, please turn off the anti-virus software or firewall and then try it again.

### 3. Wiring the Power Inputs

The Upper Panel of the **Industrial Managed Switch** indicates a DC inlet power socket and consists of one terminal block connector within 6 contacts. Please follow the steps below to insert the power wire.

1. Insert positive/negative DC power wires into Contacts 1 and 2 for Power 1, or Contacts 5 and 6 for Power 2.

**IGS-5225-8T2S2X:** 12~48V DC, 24V AC

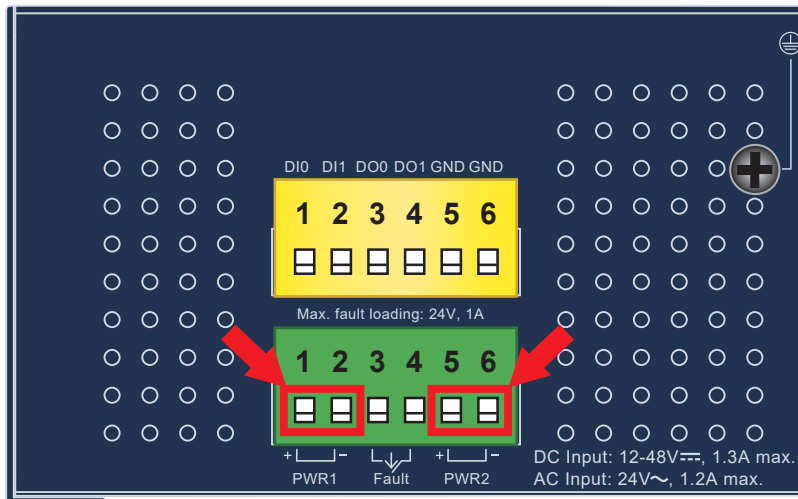


Figure 3-1: IGS-5225-8T2S2X Upper Panel

**IGS-5225-8P2S2X:** 48~54V DC

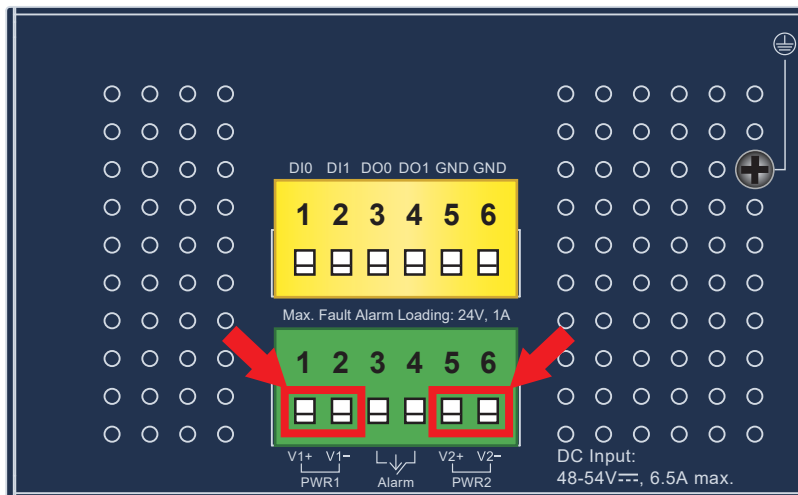
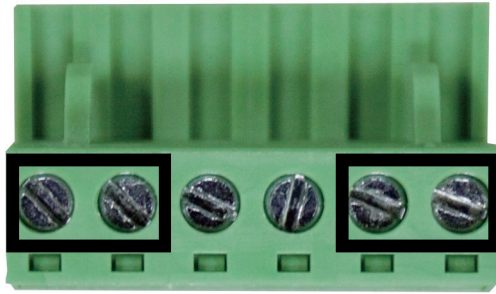


Figure 3-2: IGS-5225-8P2S2X Upper Panel

2. Tighten the wire-clamp screws for preventing the wires from loosening.



1    2    3    4    5    6  
 V+   V-          V+   V-  
 Power 1                      Power 2

Model	Positive (+) Pin	Negative (-) Pin
IGS-5225-8T2S2X	Pin 1/5	Pin 2/6
IGS-5225-8P2S2X		



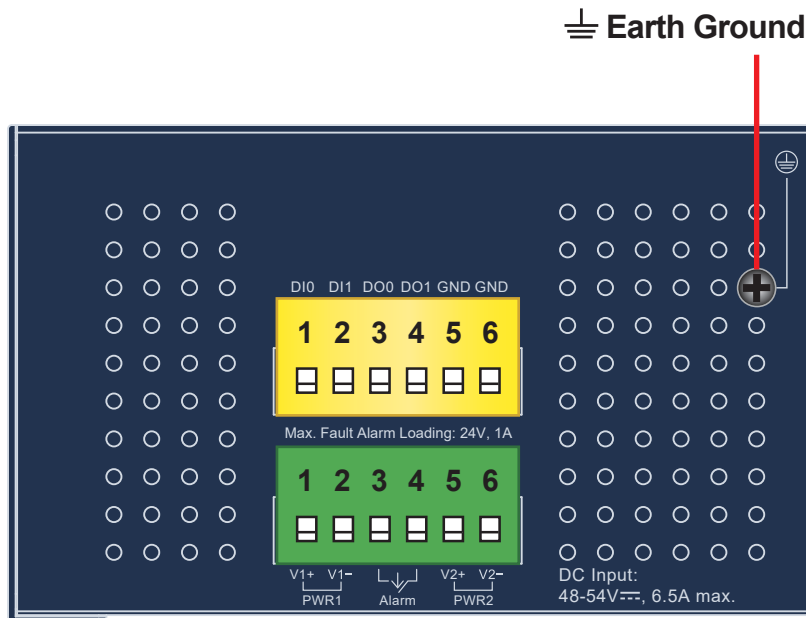
Note

The wire gauge for the terminal block should be in the range from **12** to **24 AWG**.

Please check the wired AWG ampere specification before connecting PLANET industrial switch.

### 3.1 Grounding the Device

Users **MUST** complete grounding wired with the device; otherwise, a sudden lightning could cause fatal damage to the device.



Note

EMD (Lightning) DAMAGE IS NOT COVERED UNDER WARRANTY.

## 4. Terminal Setup

To configure the system, connect a serial cable to a **COM port** on a PC or notebook computer and to RJ45 type serial (console) port of the Industrial Managed Switch. The console port of the Industrial Managed Switch is DCE already, so that you can connect the console port directly through PC without the need of null modem.

### IGS Industrial Managed Switch



RJ45 to DB9 RS232 Cable



### PC/Workstation with Terminal Emulation Software

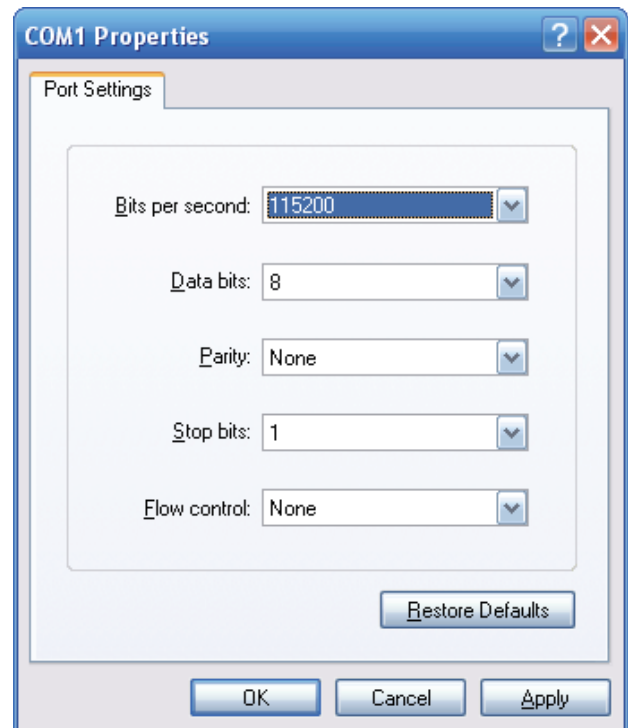


Serial Port

**Figure 4-1:** Industrial Managed Switch Console Connectivity

A terminal program is required to make the software connected to the Industrial Managed Switch.

1. Run terminal program on the OS.
2. When the following screen appears, make sure that the COM port should be configured as:
  - ◆ Baud: 115200
  - ◆ Parity: None
  - ◆ Data bits: 8
  - ◆ Stop bits: 1
  - ◆ Flow control: None



**Figure 4-2:** COM Port Configuration



## 4.1 Logging on the Console

Once the terminal has been connected to the device, power on the Industrial Managed Switch and the terminal will display “running testing procedures”.

Then, the following message asks to login user name and password. The factory default user name and password are shown as follows and the login screen in Figure 4-3 appears.



Note

The following console screen is based on the firmware version before **July of 2024**.

User Name: **admin**

Password: **admin**

```
Press ENTER to get started
Username: admin
Password:
IGS-5225-Series#
```

Figure 4-3: Console Login Screen

The user can now enter commands to manage the Industrial Managed Switch. For a detailed description of the commands, please refer to the following chapters.



Note

1. For security reason, **please change and memorize the new password after this first setup.**
2. Only accept command in lowercase letter under console interface.



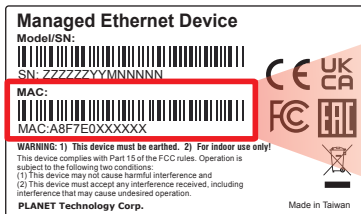
Note

The following console screen is based on the firmware version of **July of 2024 or after**.

User Name: **admin**

Password: **sw + the last 6 characters of the MAC ID in lowercase**

Find the MAC ID on your device label. The default password is "sw" followed by the last six lowercase characters of the MAC ID.



MAC ID: A8F7E0XXXXXX  
Default Password: swXXXXXX  
("x" means the last 6 digits of the MAC address.  
All characters should be in lowercase.)

**Figure 4-4:** Industrial Managed Switch MAC ID Label

Enter the default username and password, then set a new password according to the rule-based prompt and confirm it. Upon success, press any key to return to the login prompt. Log in with "admin" and the "new password" to access the CLI.

```
Generating file "startup-config.cfg"
===== Generating Startup Config Fil

===== Backup Config File Synchroniz
===== Backup Config File Synchroniz

Press any key to continue
Username: admin
Password: b*77*9*****
You are required to change and store
Please store your new password in a
Once configured, also store a copy o
Password: The password must contain
(New)Password: *****
Verify (New)Password: *****
Success.
Press any key to continue
Username: admin
Password: *****
IGS-5225-Series#
```

**Figure 4-5:** Create a New Password and Login Again

## 4.2 Configuring IP Address via Console

The Industrial Managed Switch is shipped with default IP address shown below:

```
IP Address: 192.168.0.100  
Subnet Mask: 255.255.255.0
```

To check the current IP address or modify a new IP address for the Switch, please use the procedure as follows:

### ■ Display of the current IP Address

1. At the “#” prompt, enter “**show ip interface brief**”.
2. The screen displays the current IP address shown in Figure 4-6.

```
IGS-5225-Series# show ip interface brief  
Vlan Address Method Status  
-----  
1 192.168.0.100/24 Manual UP  
IGS-5225-Series#
```

Figure 4-6: IP Information Screen

### ■ Configuration of the IP Address

3. At the “#” prompt, enter the following command and press <Enter> as shown in Figure 4-7.

```
IGS-5225-Series# configure terminal  
IGS-5225-Series (config)# interface vlan 1  
IGS5225-Series (config-if-vlan)# ip address 192.168.1.100 255.255.255.0
```

The previous command would apply the following settings for the Industrial Managed Switch.

```
IP Address: 192.168.1.100  
Subnet Mask: 255.255.255.0
```

```
IGS-5225-Series# configure terminal  
IGS-5225-Series(config)# interface vlan 1  
IGS-5225-Series(config-if-vlan)# ip address 192.168.1.100 255.255.255.0  
IGS-5225-Series(config-if-vlan)#
```

Figure 4-7: Configuring IP Address Screen

4. Repeat step 1 to check if the IP address has changed.

### 4.3 Storing the Current Switch Configuration

1. At the “#” prompt, enter the following command and press **<Enter>**.

```
# copy running-config startup-config
```

```
IGS-5225-Series# copy running-config startup-config
Building configuration...
% Saving 3514 bytes to flash:startup-config
IGS-5225-Series#
```

**Figure 4-8:** Saving Current Configuration Command Screen

If the IP is successfully configured, the Industrial Managed Switch will apply the new IP address setting immediately. You can access the Web interface of the Industrial Managed Switch through the new IP address.



Note

If you are not familiar with the console command or the related parameter, enter “help” anytime in console to get the help description.

## 5. Starting Web Management

The following shows how to start up the **Web Management** of the Industrial Managed Switch. Note the Industrial Managed Switch is configured through an Ethernet connection. Please make sure the manager PC must be set to the same **IP subnet address**.

For example, the default IP address of the Industrial Managed Switch is **192.168.0.100**, then the manager PC should be set to **192.168.0.x** (where x is a number between 1 and 254, except 100), and the default subnet mask is 255.255.255.0.

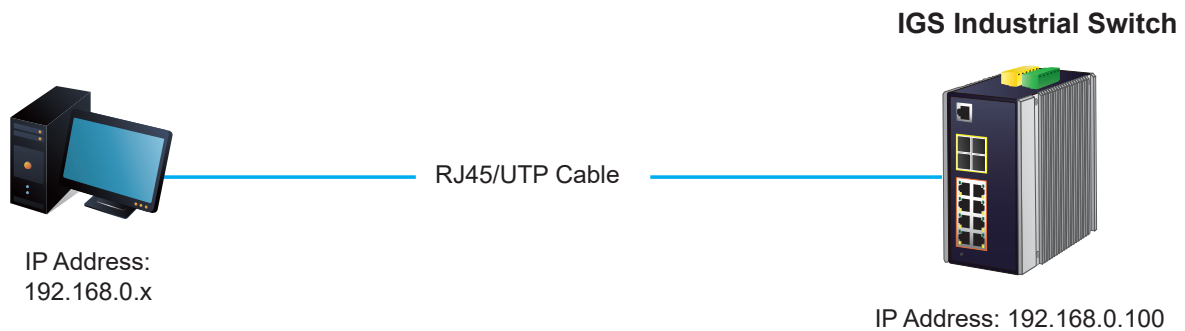


Figure 5-1: IP Management Diagram

### 5.1 Logging in to the Industrial Managed Switch

1. Use Chrome 98.0.xx or above for Web browser and enter IP address **<https://192.168.0.100>** (the factory-default IP address) to access the Web interface.

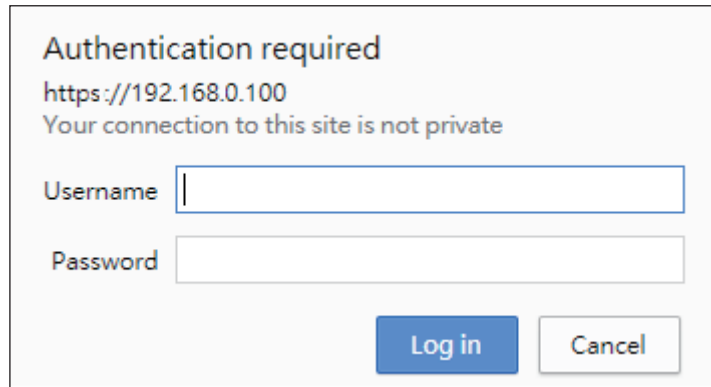


Note


The following web screen is based on the firmware version before **July of 2024**.

- When the following dialog box appears, please enter the default user name **"admin"** and password **"admin"** (or the password you have changed before) as shown in Figure 5-2.


Default IP Address: **192.168.0.100**  
Default User Name: **admin**  
Default Password: **admin**



**Figure 5-2:** Login Screen

 The following web screen is based on the IGS-5225-8P2S2X; the display of the IGS-5225-8T2S2X is the same as that of the IGS-5225-8P2S2X.

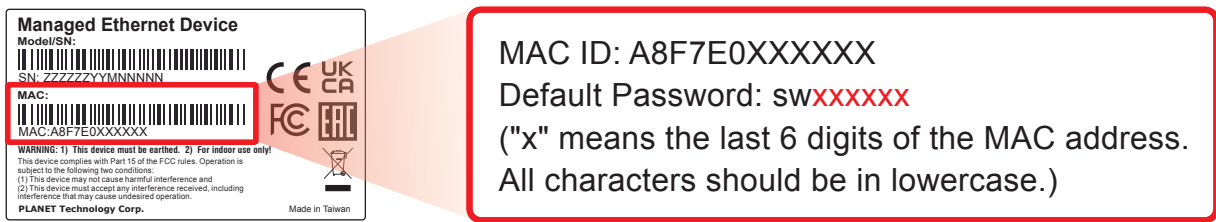
- After entering the password, the main screen appears as shown in Figure 5-6.

 The following web screen is based on the firmware version of **July of 2024 or after**.

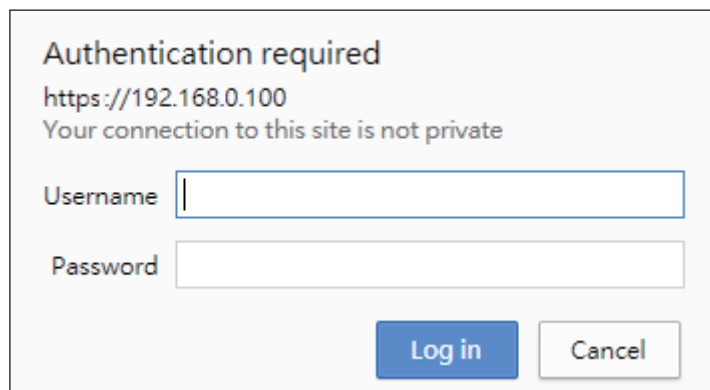
- When the following dialog box appears, please enter the default user name **"admin"** and password. Refer to **Section 4.1** to determine your initial login password.

Default IP Address: **192.168.0.100**  
Default User Name: **admin**  
Default Password: **sw + the last 6 characters of the MAC ID in lowercase**

- Find the MAC ID on your device label. The default password is "sw" followed by the last six lowercase characters of the MAC ID.

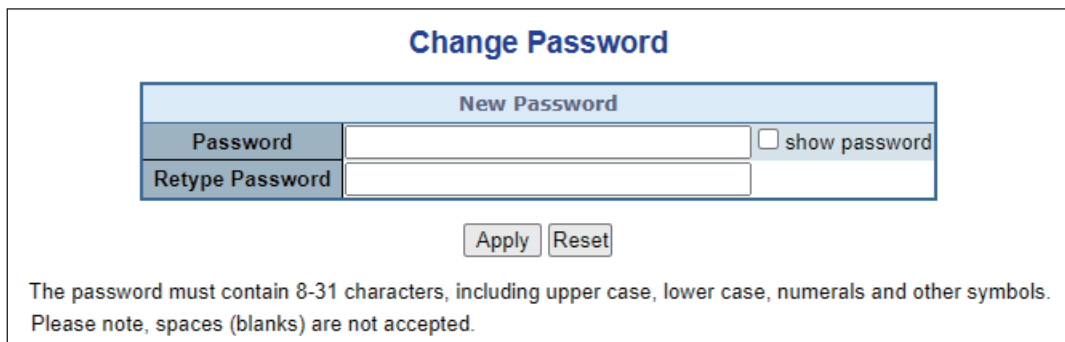


**Figure 5-3:** Industrial Managed Switch MAC ID Label



**Figure 5-4:** Login Screen

- After logging in, you will be prompted to change the initial password to a permanent one.



**Figure 5-5:** Create a New Password

7. Enter the default username and password, then set a new password according to the rule-based prompt and confirm it. Upon success, press any key to return to the login prompt. Log in with "admin" and the "new password" to access the Web interface.




Figure 5-6: Web Main Screen of Industrial Managed Switch

8. The Switch Main Menu is shown on top left of the Web page, and the functions are shown on the left to configure the Industrial Managed Switch.



Now, you can use the Web management interface to continue the Switch management. Please refer to the user manual for more.



Note

If you are not familiar with Switch functions or the related parameter, press **"Help icon"** anytime on the Web page to get the help description.

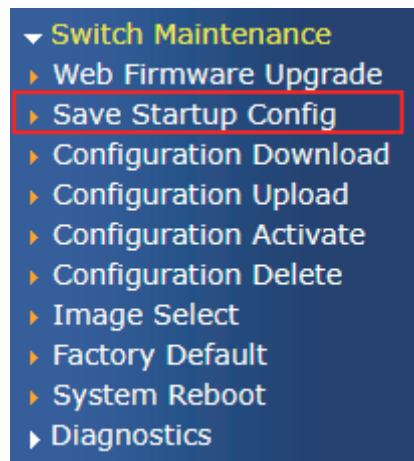


## 5.2 Saving Configuration via Web

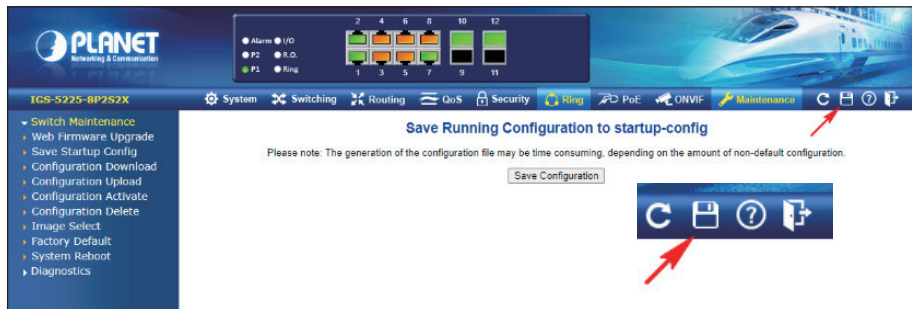
In the Industrial Managed Switch, the running configuration file stores in the RAM. In the current version, the running configuration sequence of **running-config** can be saved from the RAM to FLASH by executing save startup config command, so that the running configuration sequence becomes the startup configuration file, which is called configuration save.

To save all applied changes and set the current configuration as a startup configuration, the startup-configuration file will be loaded automatically across a system reboot.

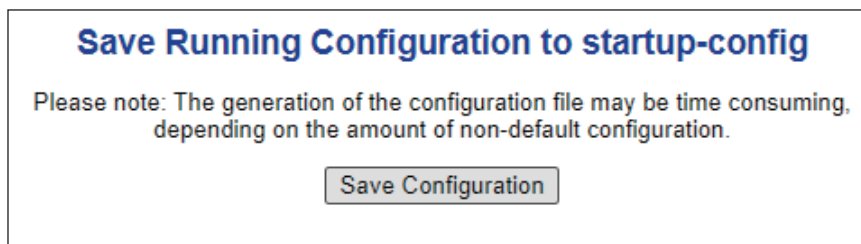
1. Click **Maintenance** > **Open Switch Maintenance on the left page** > **Press Save Startup Config.**



2. Or you can press the **“Save Configuration”** button.



3. Press the **“Save Configuration”** button to save.



## 6. Resetting the Switch to Default

To reset the IP address to the default IP Address **"192.168.0.100"** and the user name password to factory default mode (default password is admin or sw + the last 6 characters of the MAC ID in lowercase), press the hardware reset button on the front panel for about 10 seconds. After the device is rebooted, you can log in the management Web interface within the same subnet of 192.168.0.xx and default password. Be noted that all the previous setups will be disappeared after the factory default reset is made.

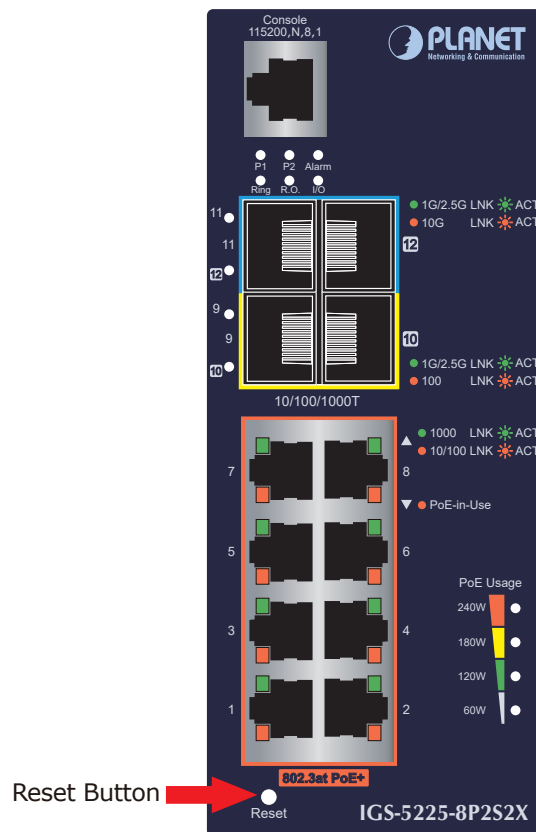


Figure 6-1: IGS-5225-8T2S2X/IGS-5225-8P2S2X Reset Button

## 7. Customer Support

Thank you for purchasing PLANET products. You can browse our online FAQ resource on PLANET web site first to check if it could solve your issue. If you need more support information, please contact PLANET switch support team.

PLANET online FAQs:

<https://www.planet.com.tw/en/support/faq>

Switch support team mail address:

[support@planet.com.tw](mailto:support@planet.com.tw)

IGS-5225-8T2S2X/IGS-5225-8P2S2X User's Manual:

<https://www.planet.com.tw/en/support/download.php?&method=keyword&keyword=IGS-5225-8&view=3#list>



(Please select your switch model name from the Product Model drop-down menu)

Copyright © PLANET Technology Corp. 2024.

Contents are subject to revision without prior notice.

PLANET is a registered trademark of PLANET Technology Corp.

All other trademarks belong to their respective owners.